

101

CHRISTMAS ACTIVITIES FOR KIDS

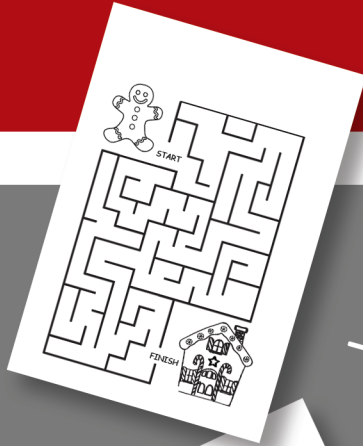

HAPPY
CHRISTMAS



This book belongs to



Name _____



2





20 CHRISTMAS COLORING ACTIVITIES FOR KIDS

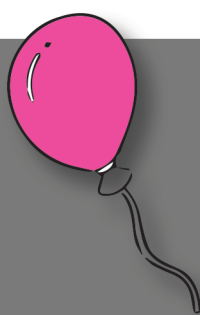

**HAPPY
CHRISTMAS**



Name _____



4





5



Name _____





Name _____





Name _____



7





8

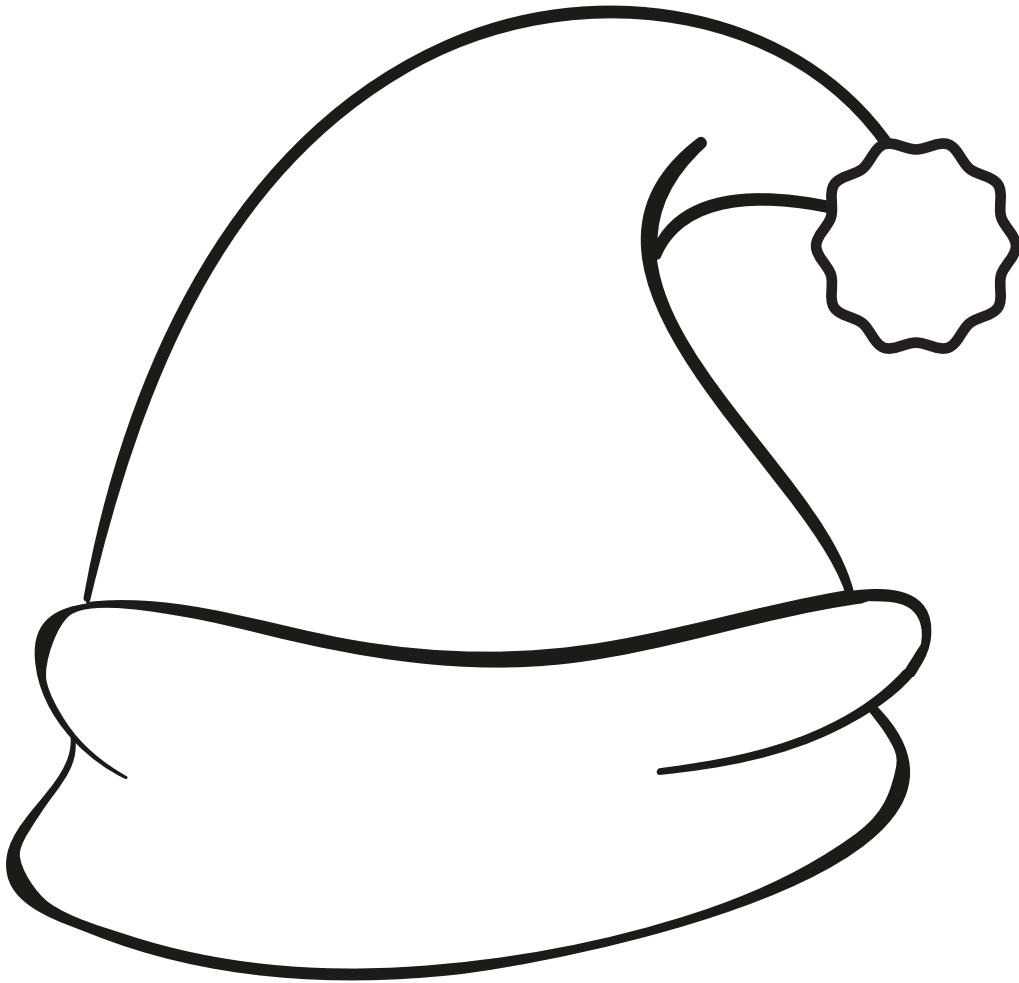

Name _____





Name _____



9





Name _____



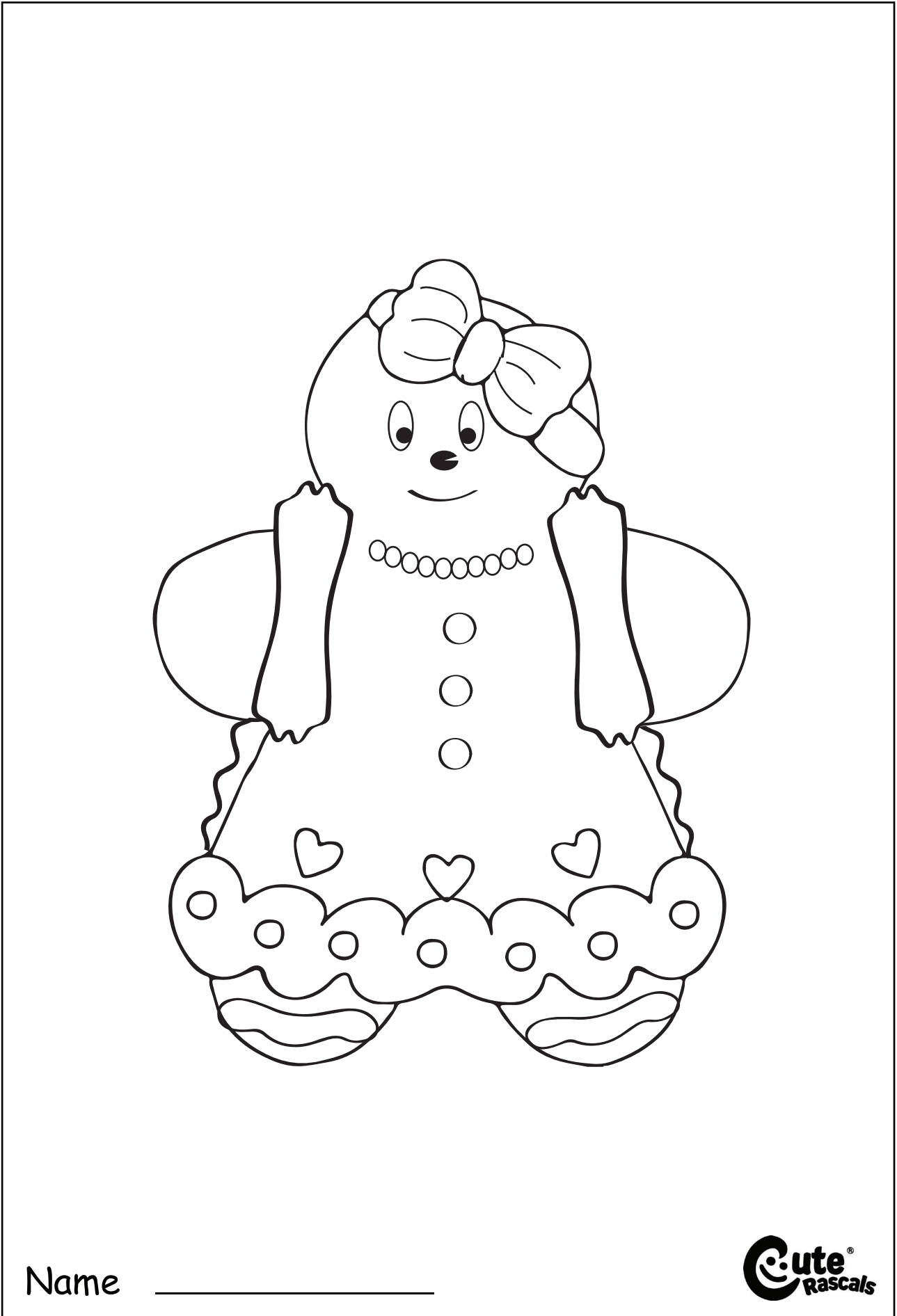

Name _____



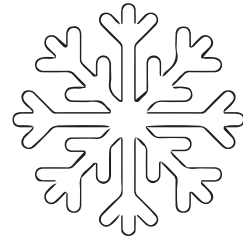
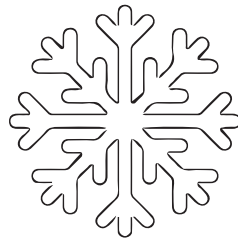

Name _____



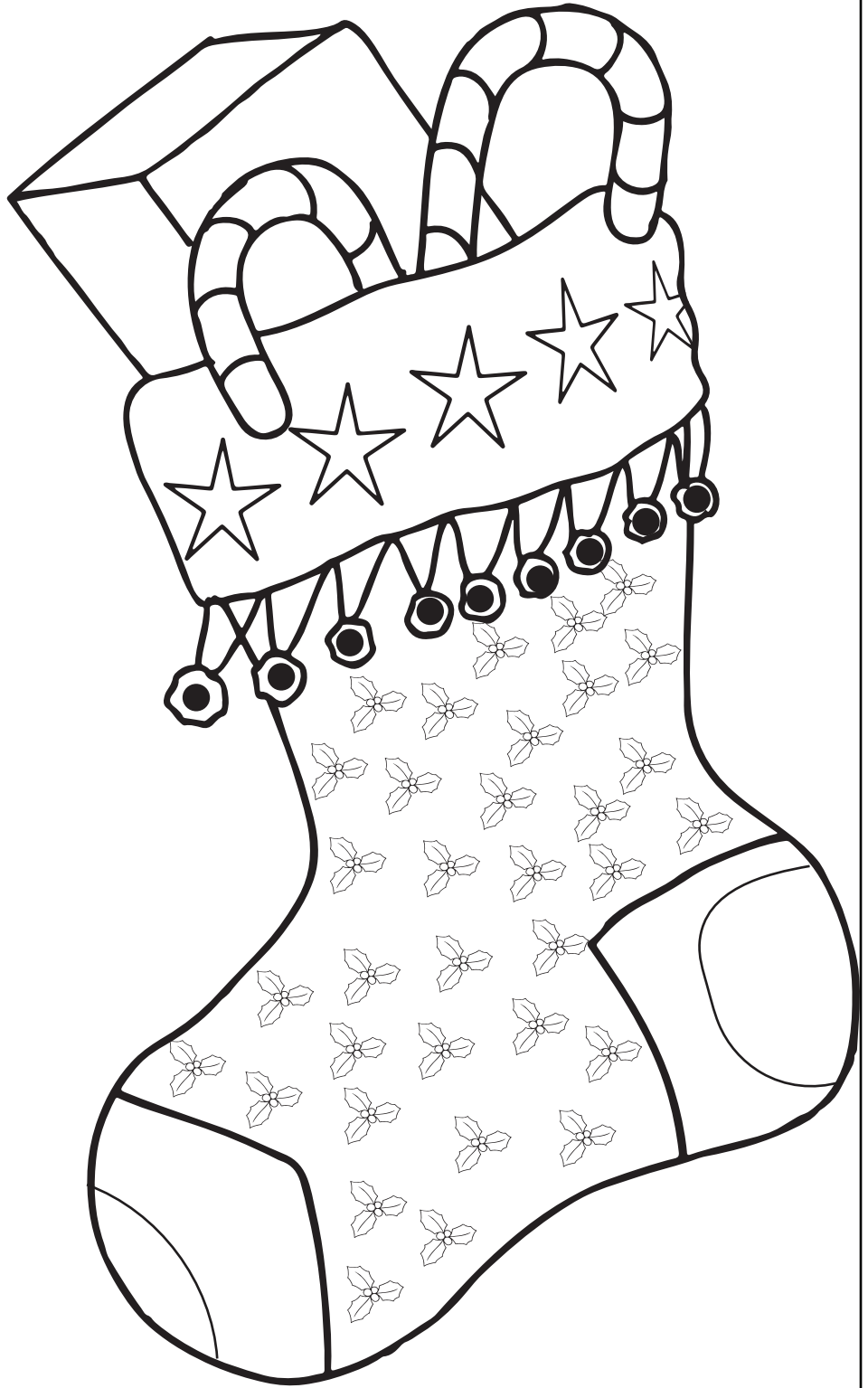

Name _____



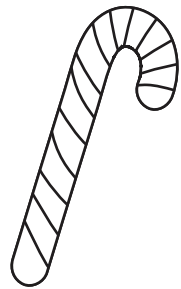
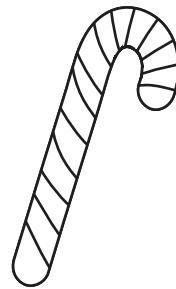
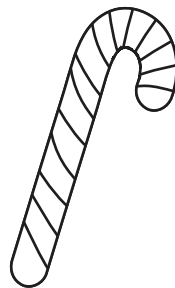
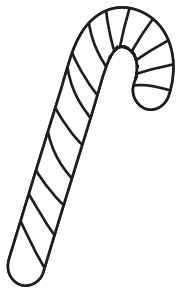
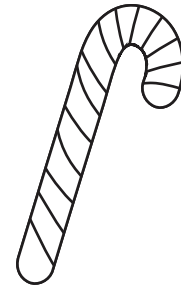
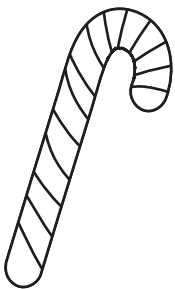
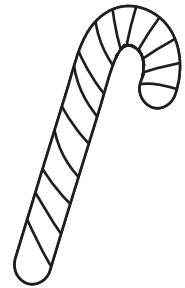
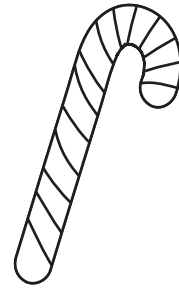
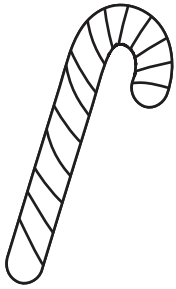
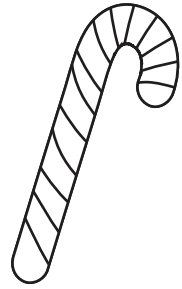
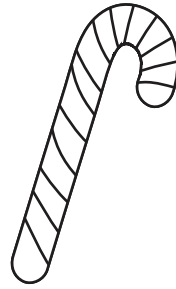
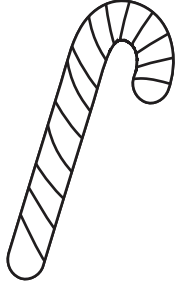
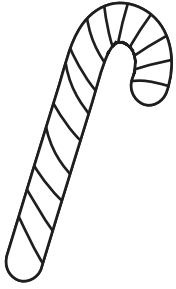

Name _____





Name _____



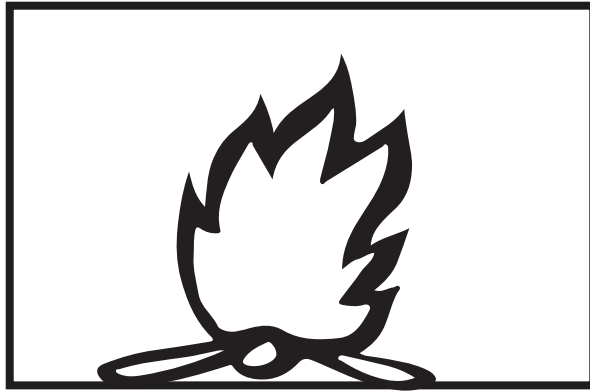
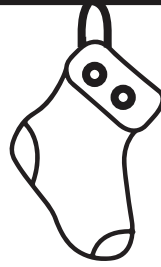
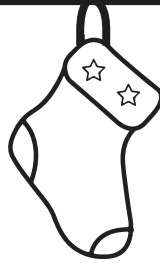
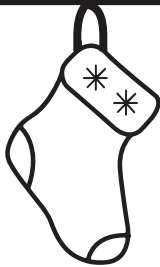

Name _____



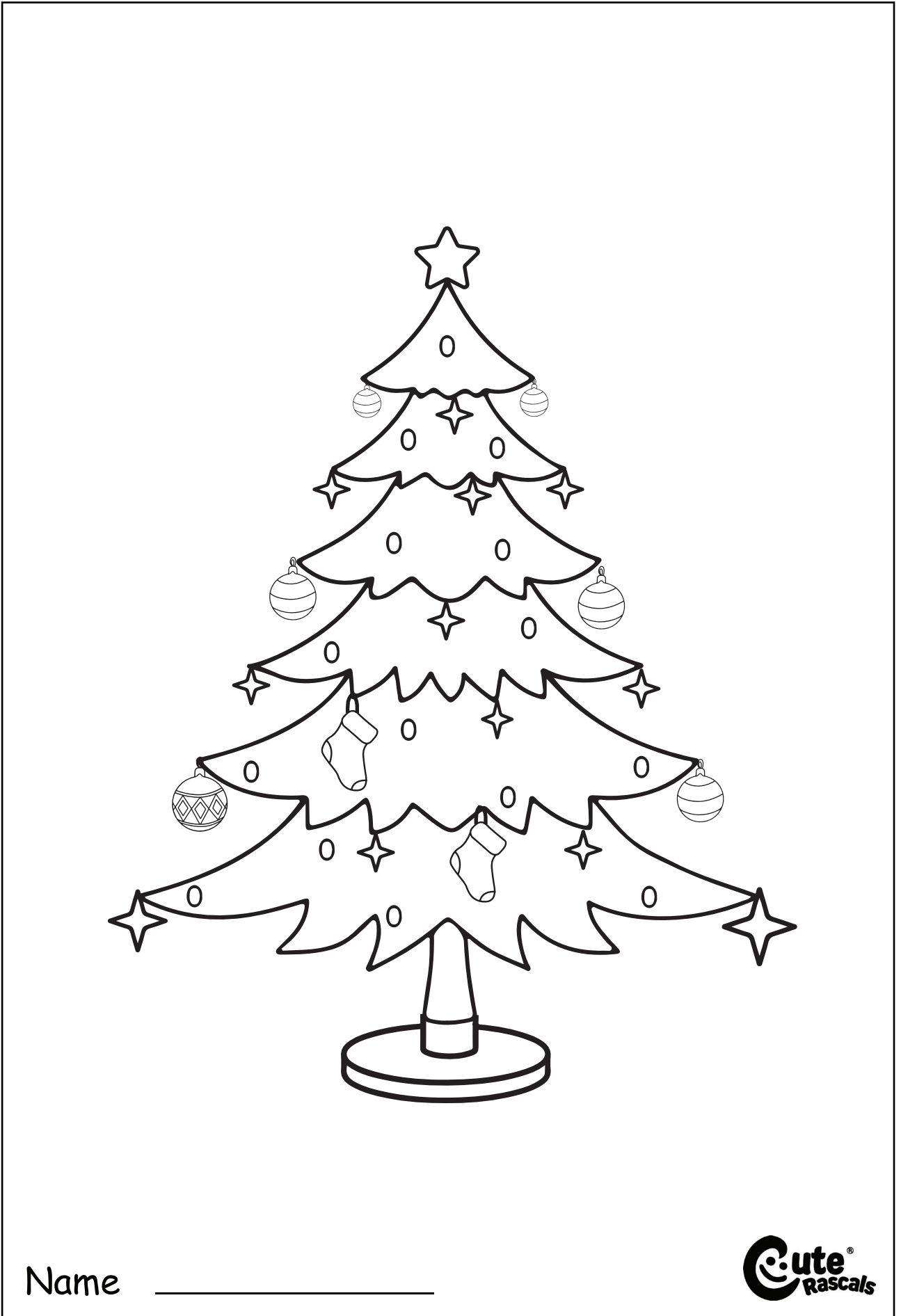

Name _____



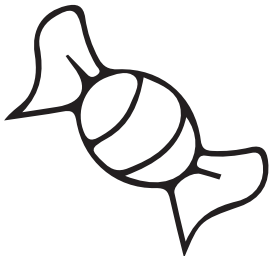
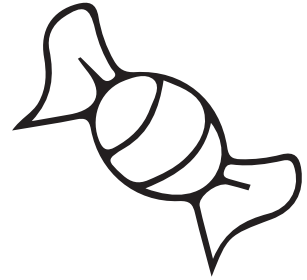
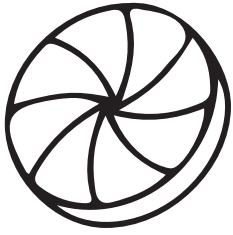

Name _____







Name _____



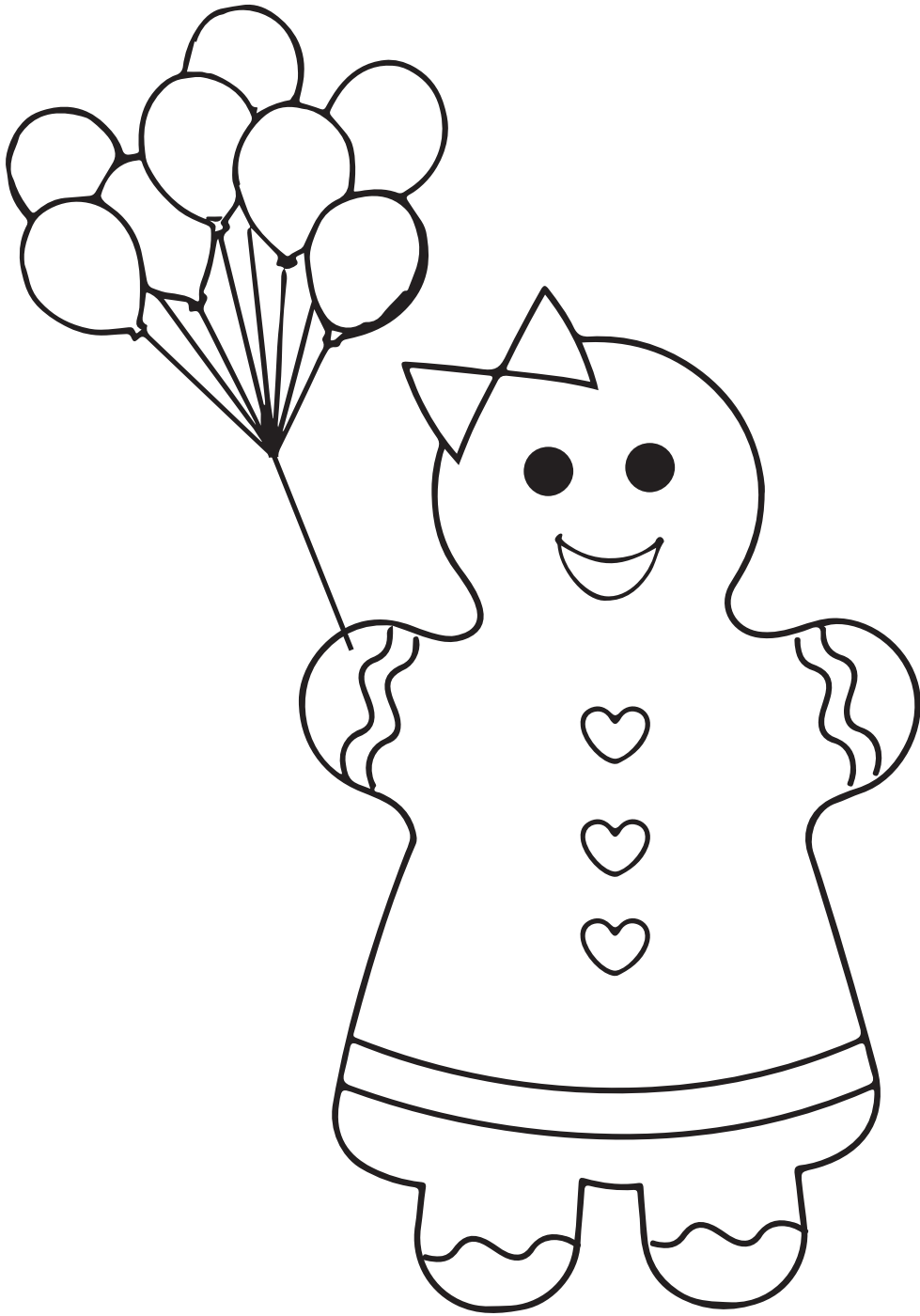

Name _____



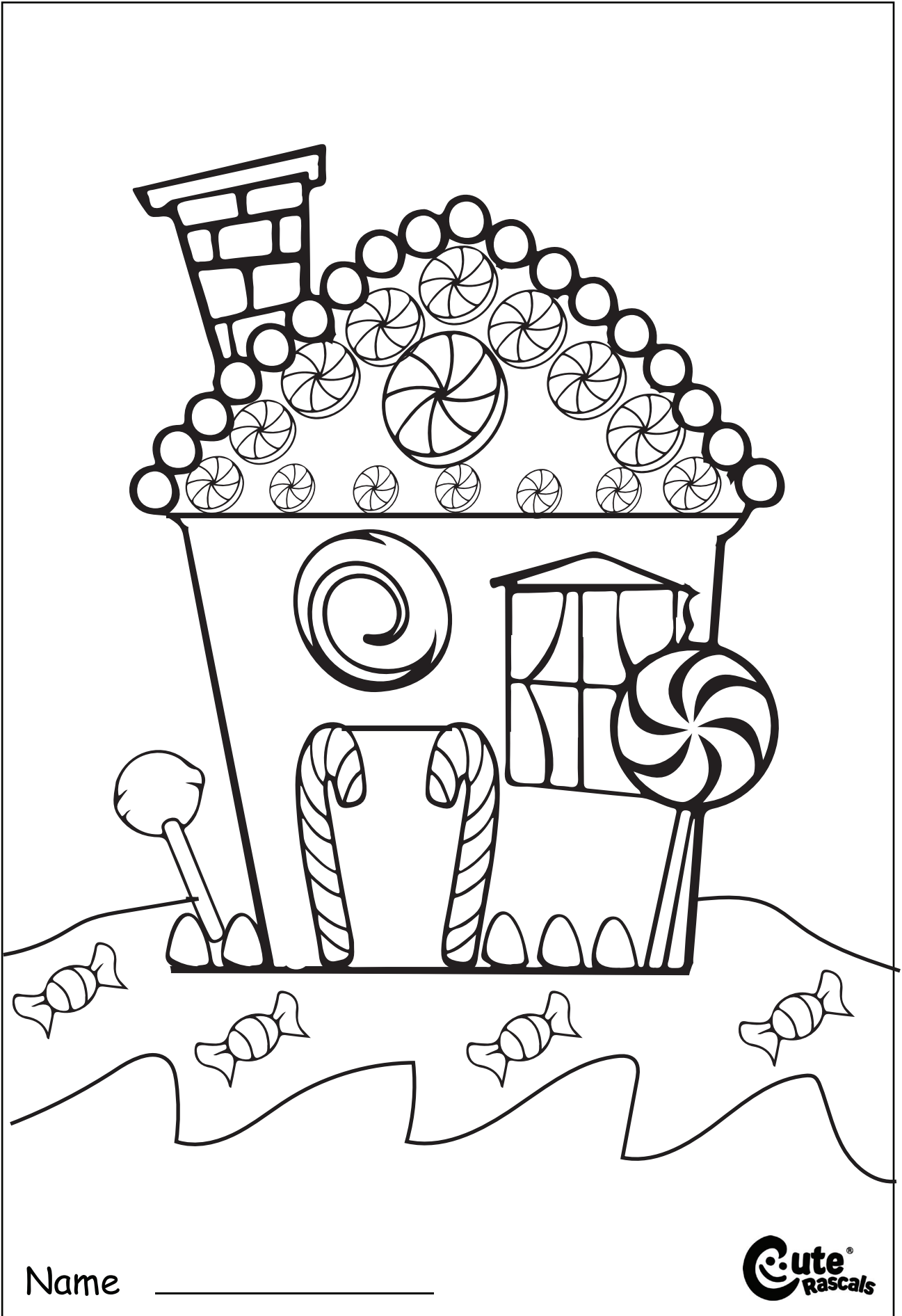

Name _____



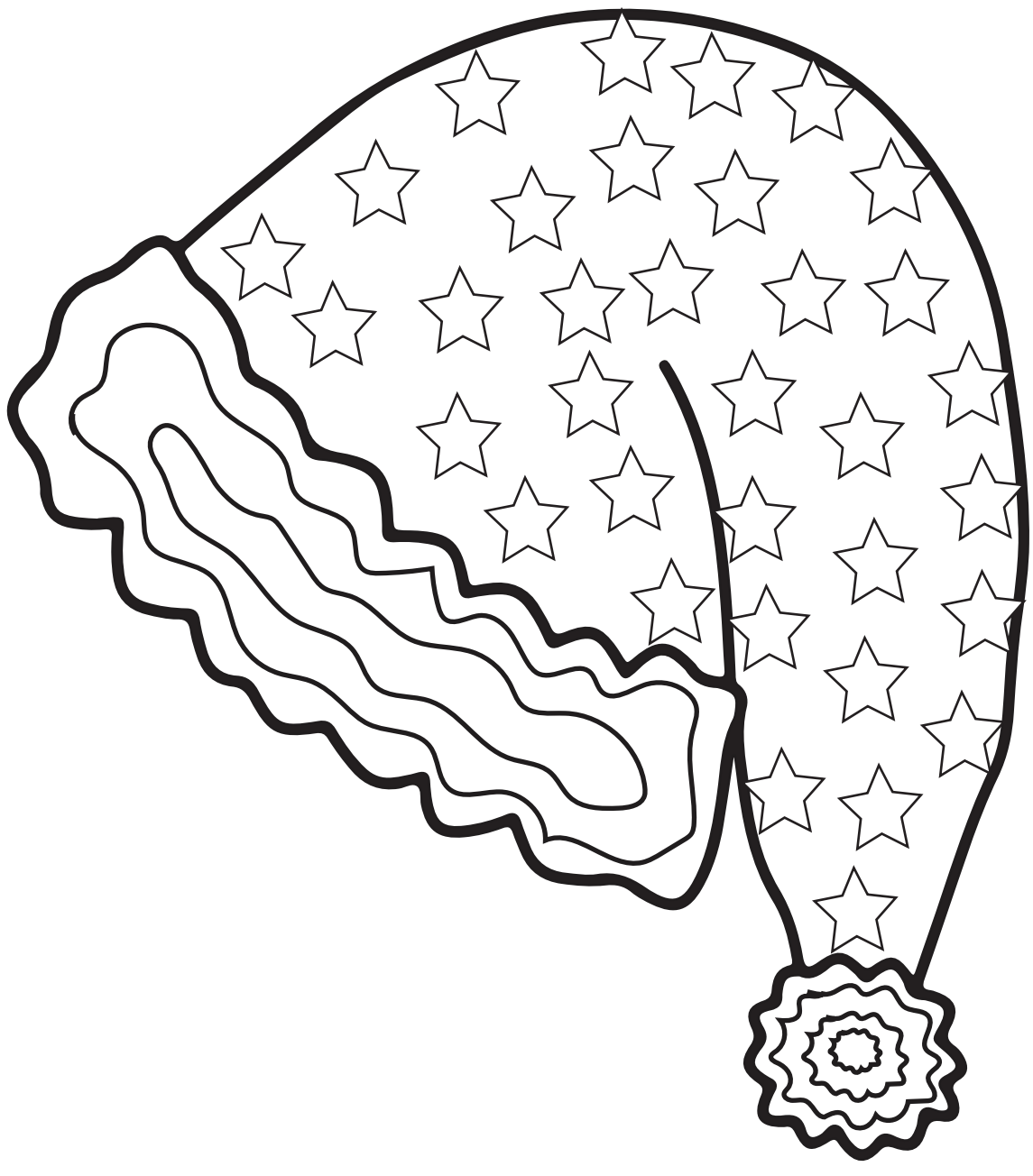
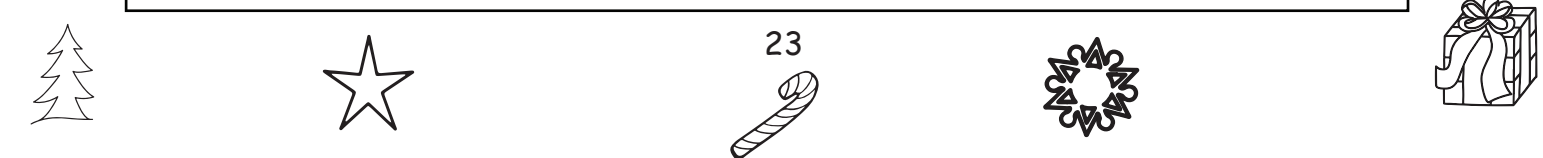

Name _____





10

CHRISTMAS COLOR BY NUMBER ACTIVITIES FOR KIDS

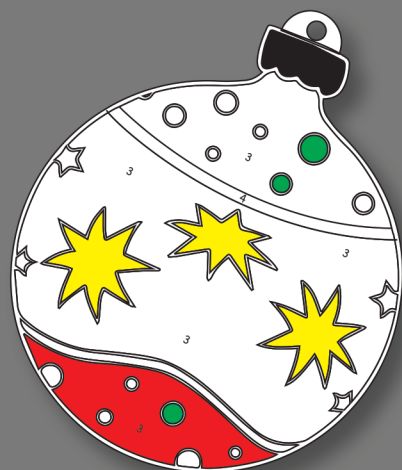
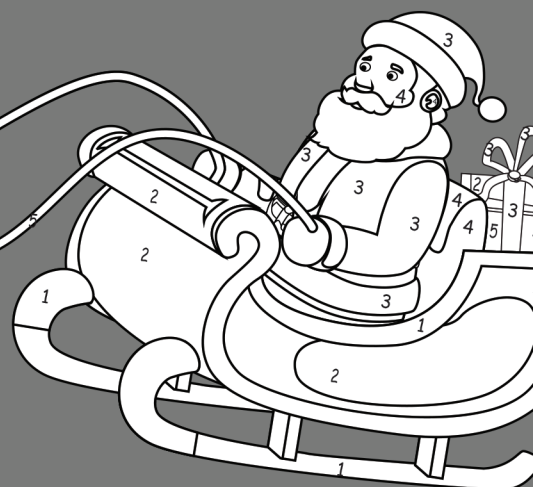

HAPPY CHRISTMAS



This book belongs to



Name _____



2



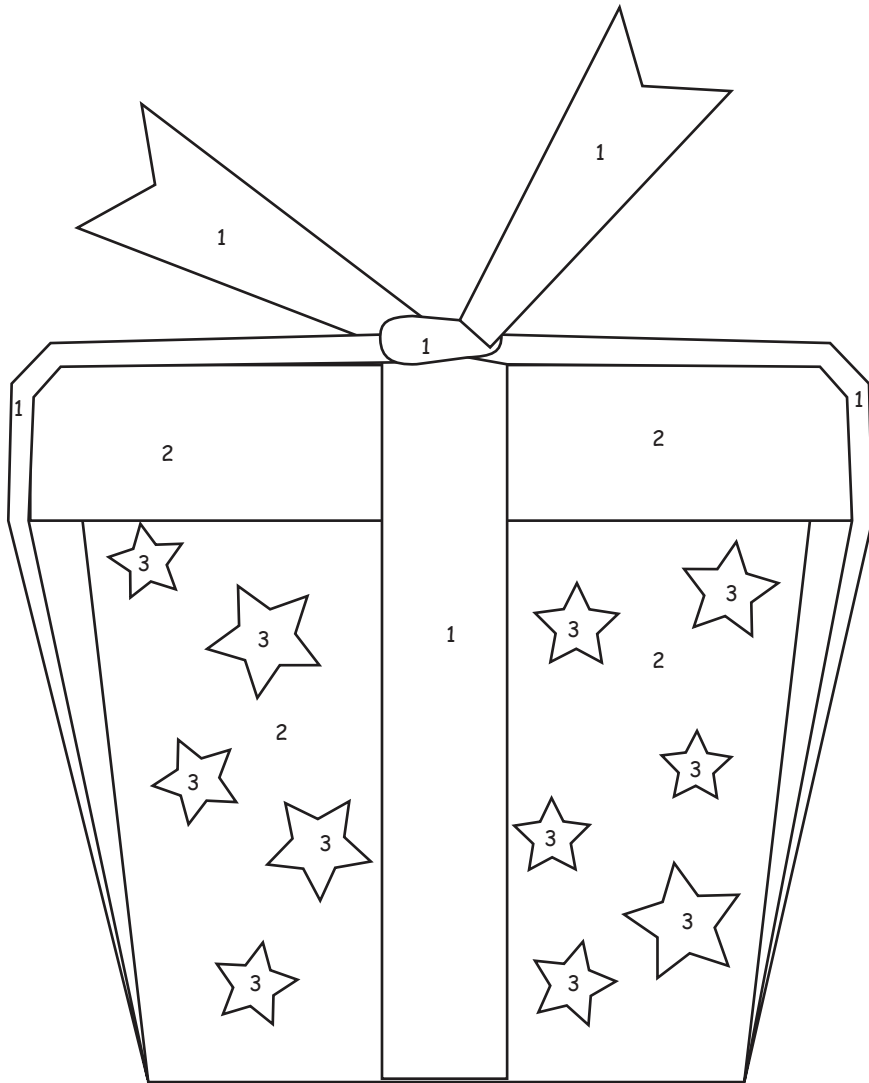

Name _____





Name _____



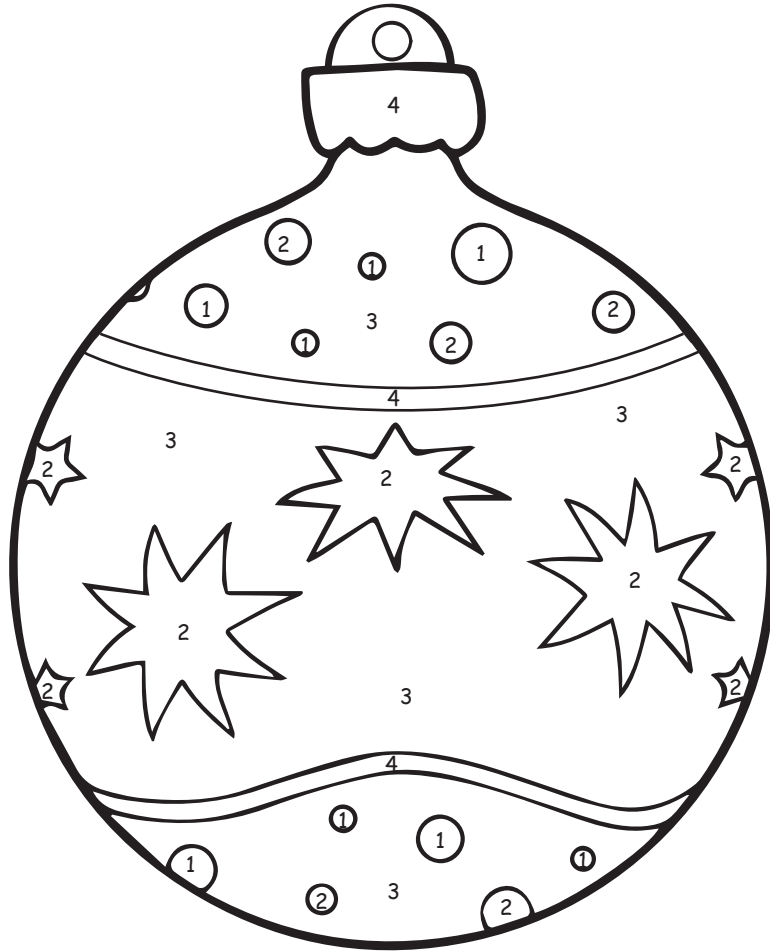

Name _____



5



6

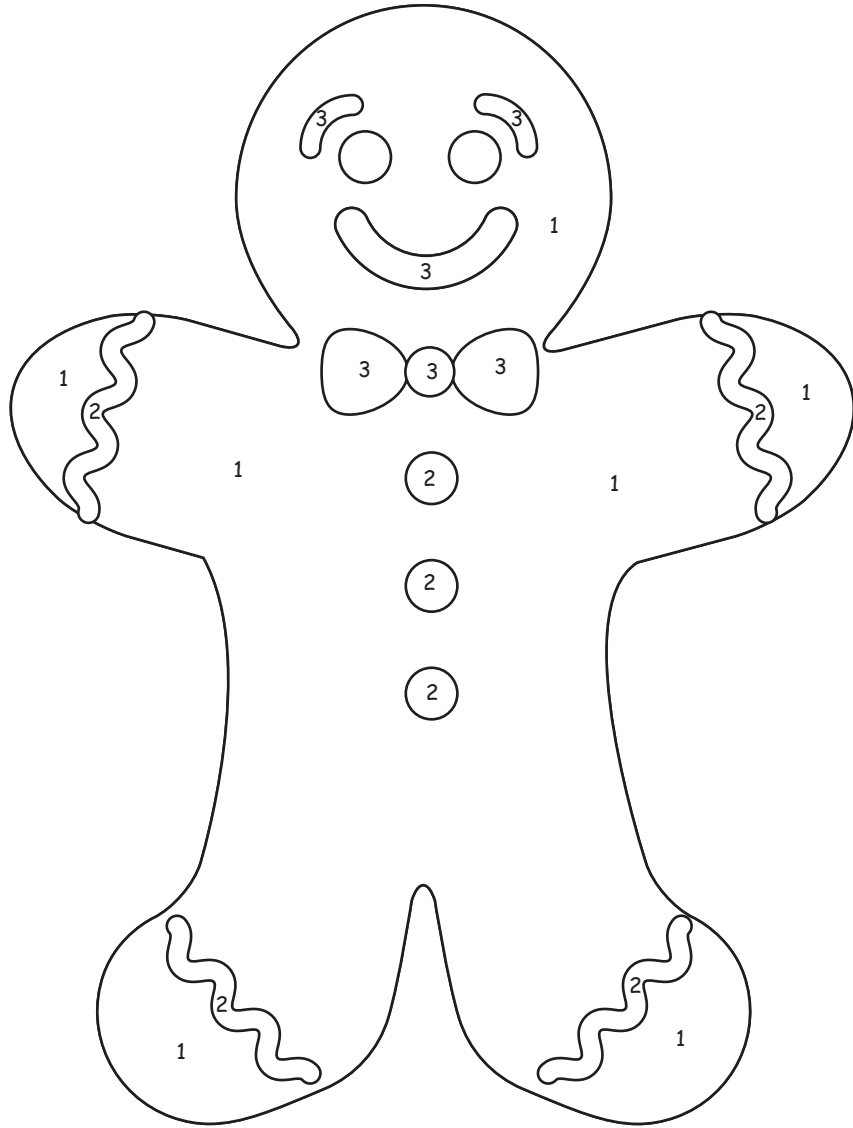

Name _____





7

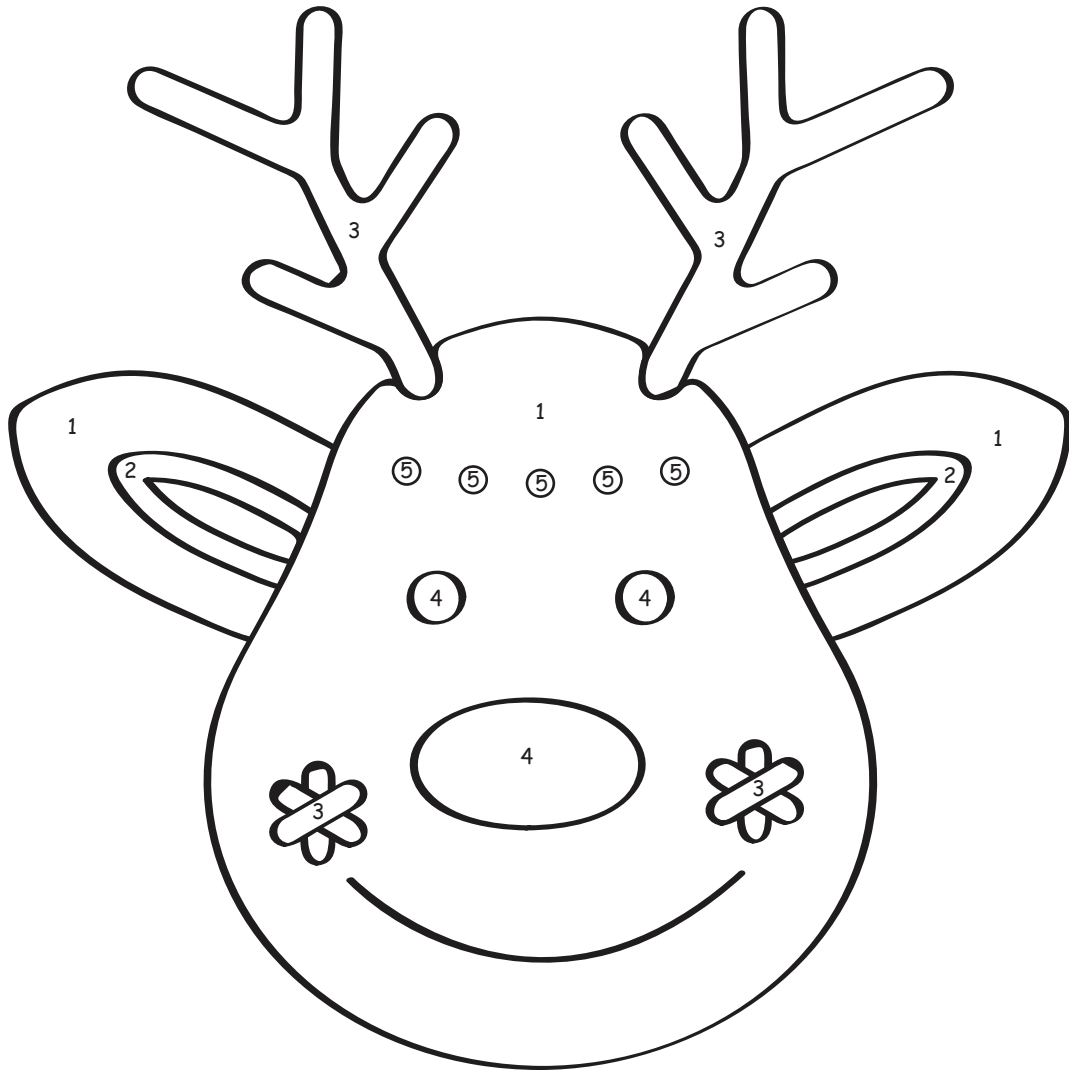

Name _____



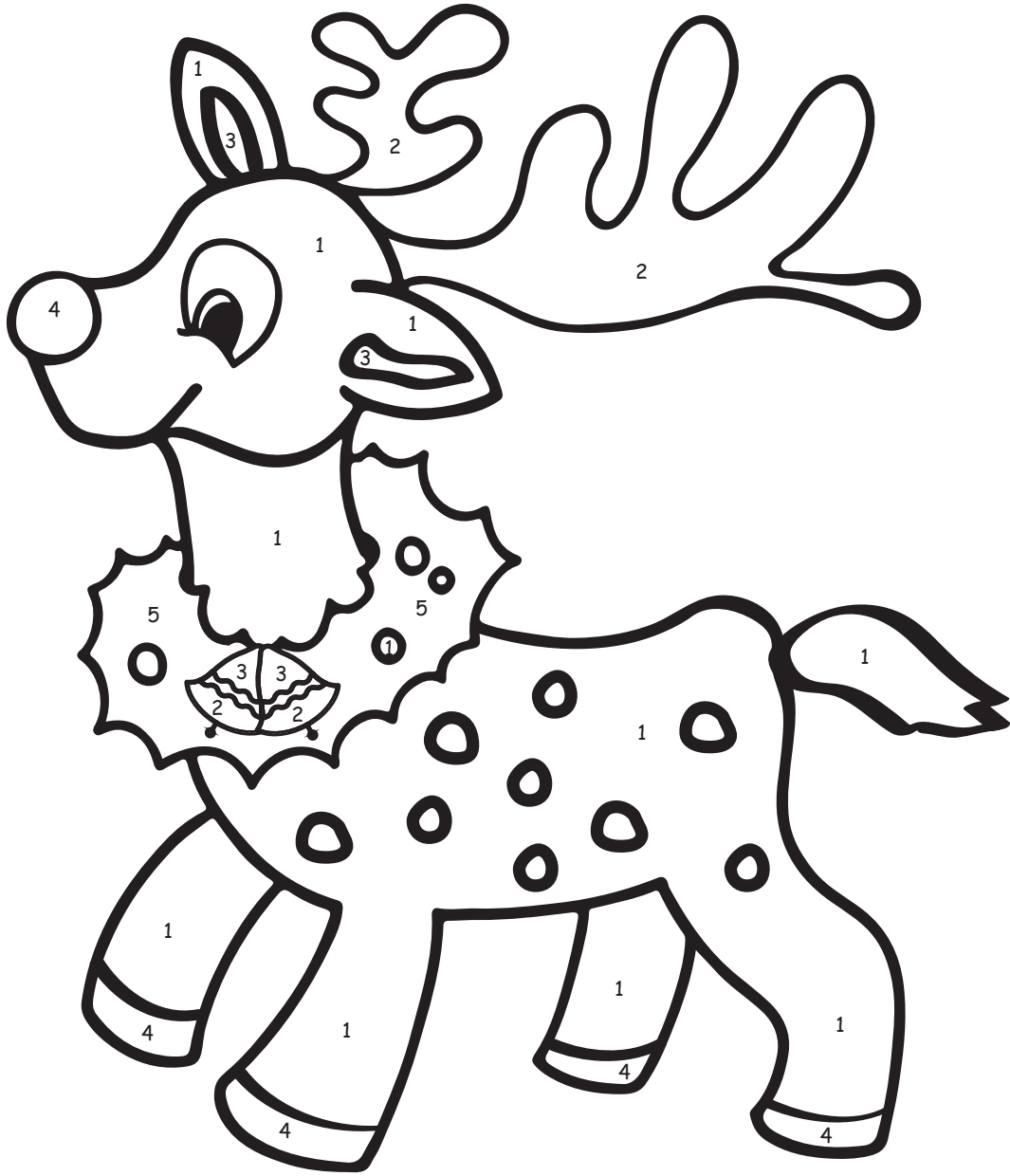

Name _____





Name _____



9





10

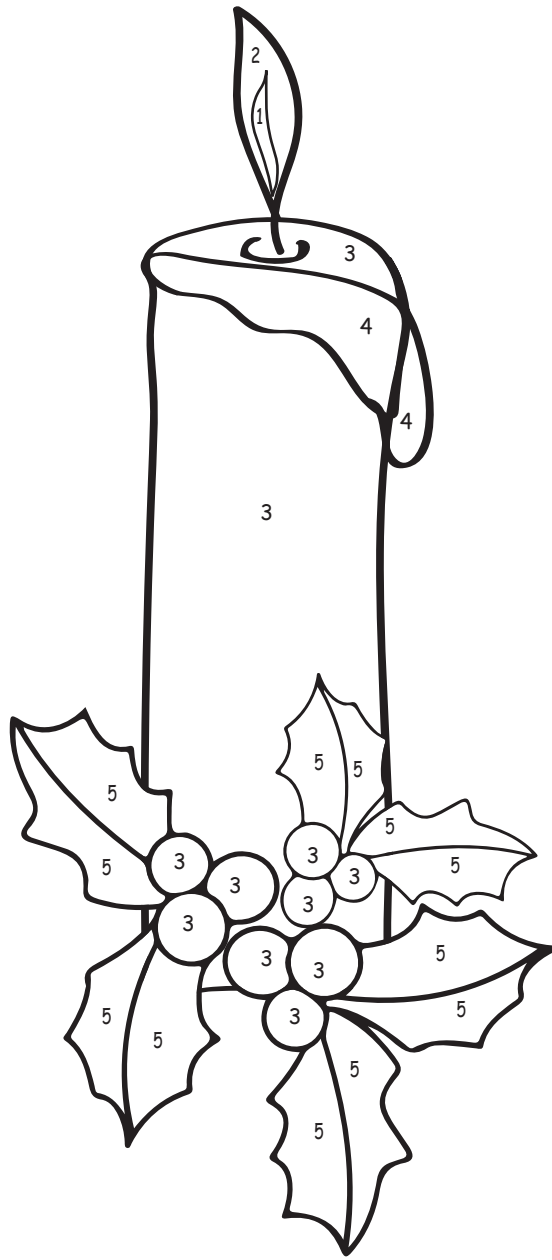

Name _____



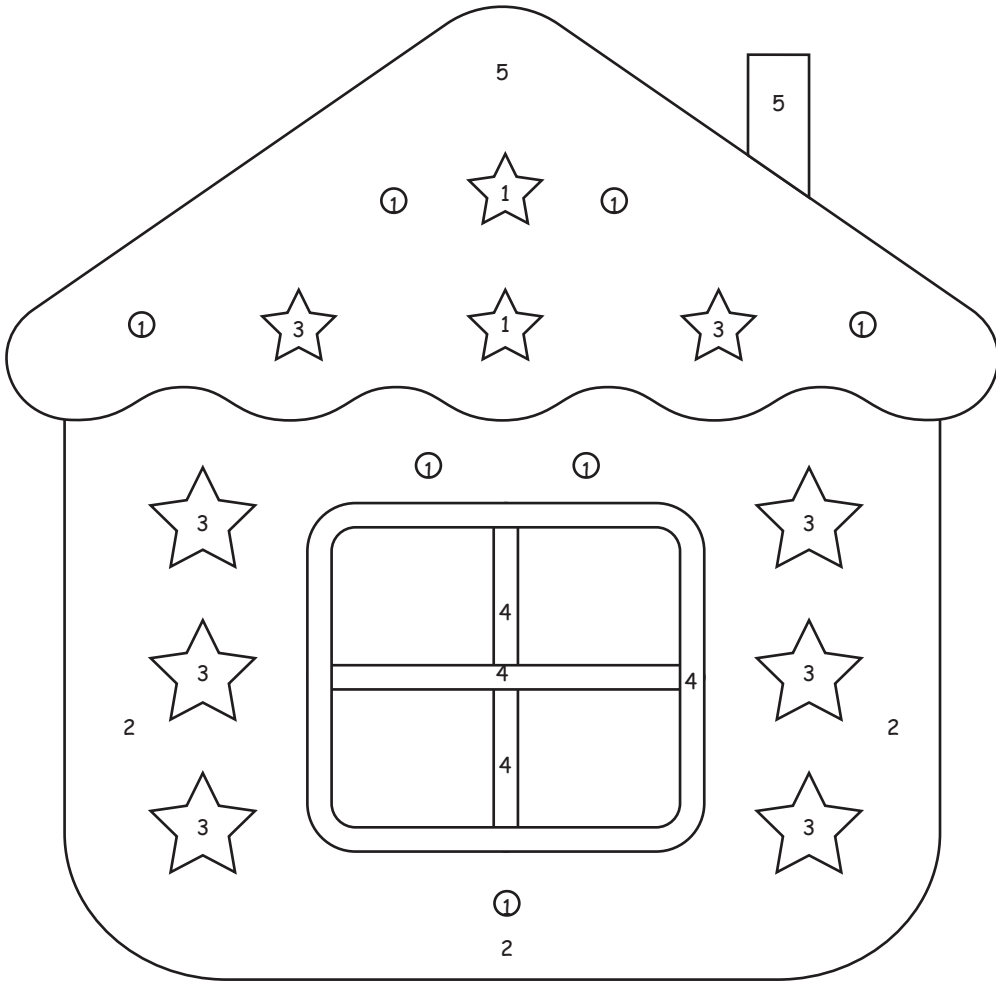

Name _____



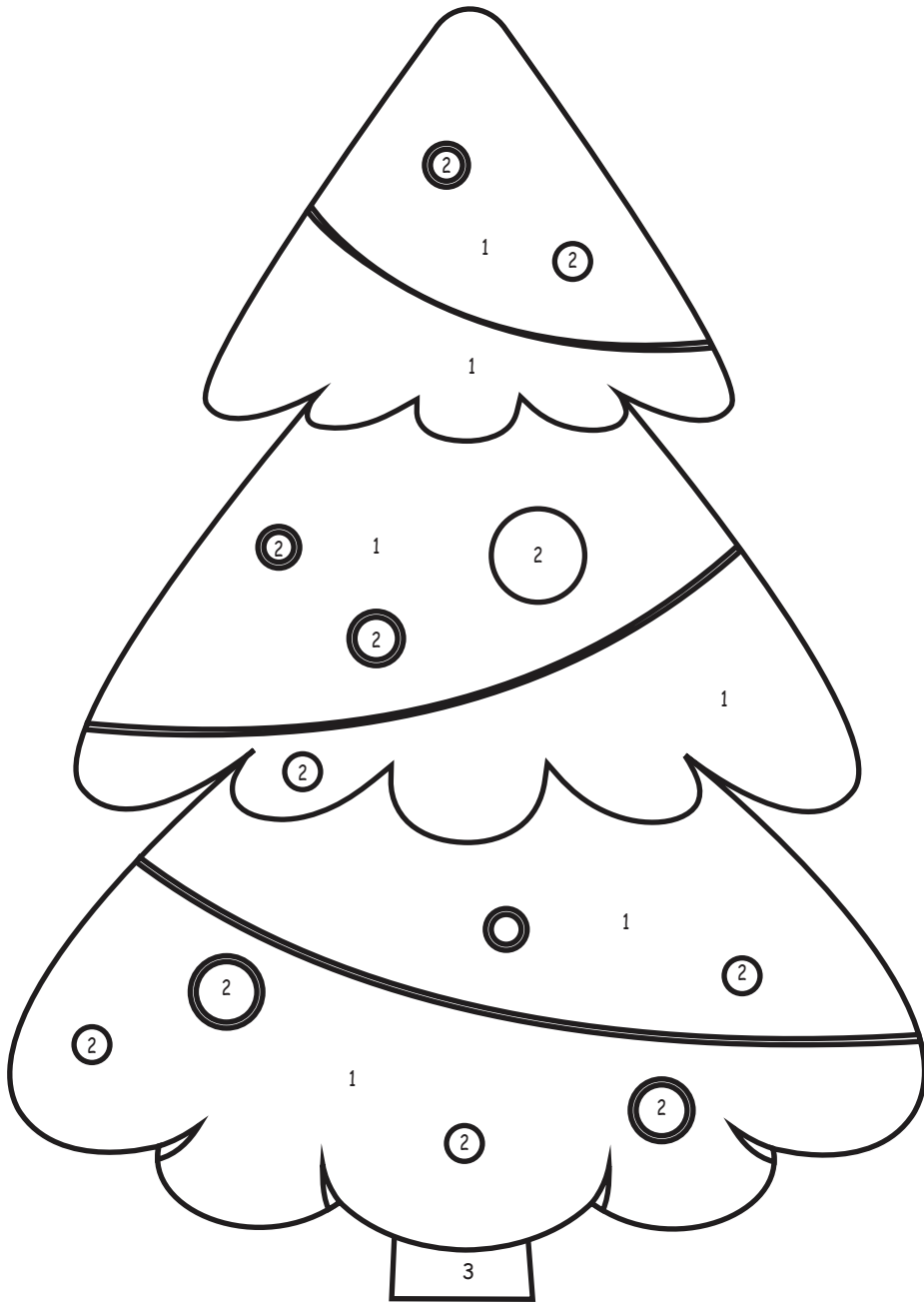

Name _____





10

CHRISTMAS DOT-TO-DOT TRACING ACTIVITIES FOR KIDS

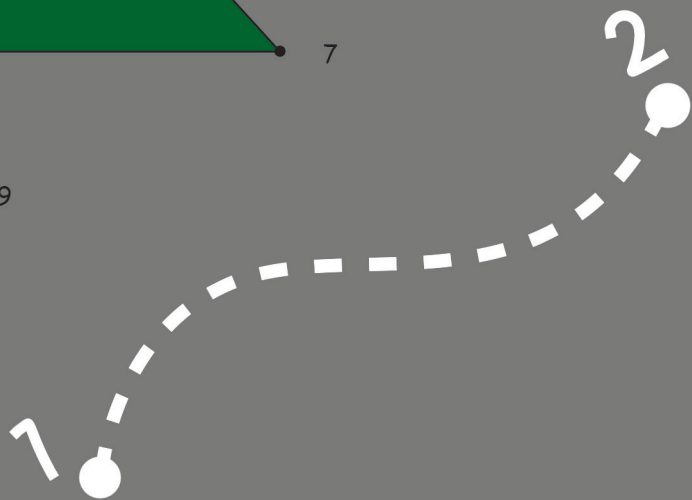
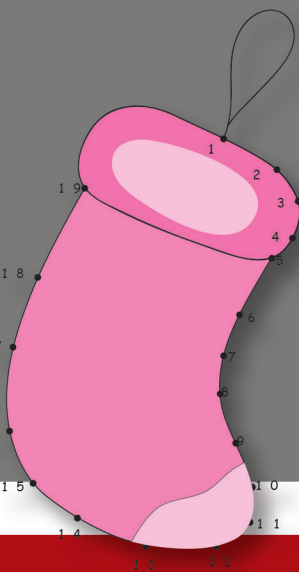
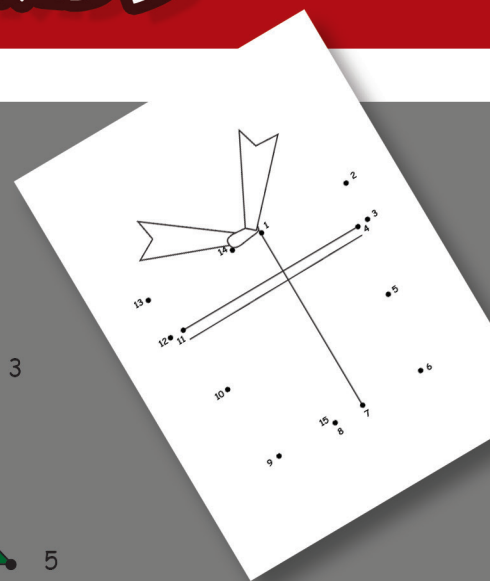
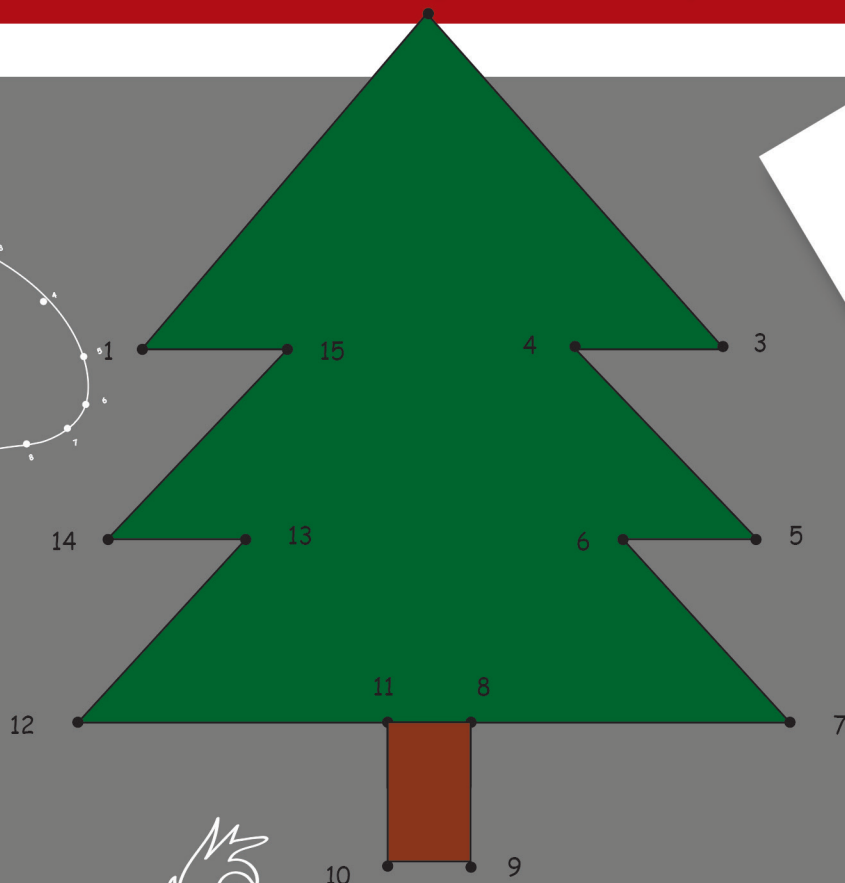
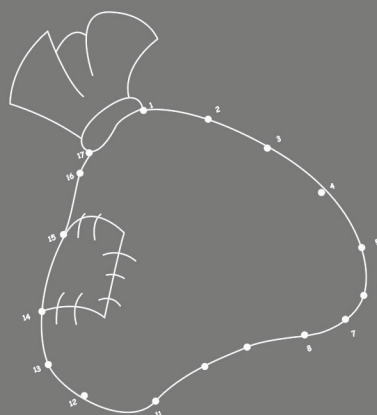

HAPPY CHRISTMAS





This book belongs to



Name _____



2





2



1 ● ————— ● 15

4 ● ● 3



14 ● ● 13

6 ● ● 5



12 ●

11 ● 8 ●

● 7



10 ● ● 9



Name _____



3





Name _____



4

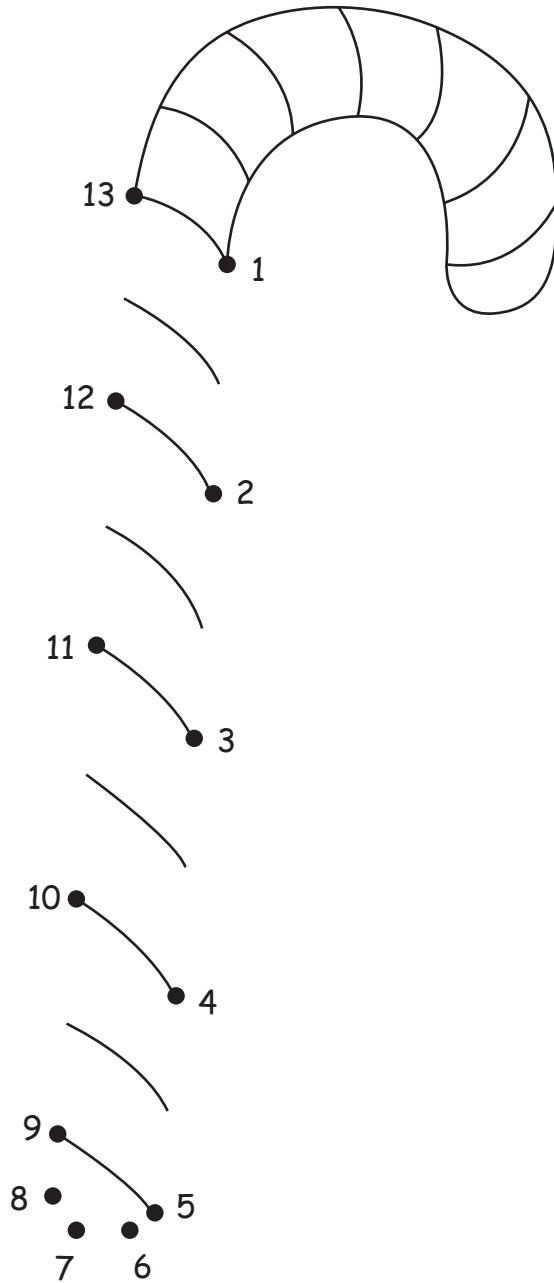

13

1

12

2

11

3

10

4

9

5

8

7

6



Name _____





Name _____



6

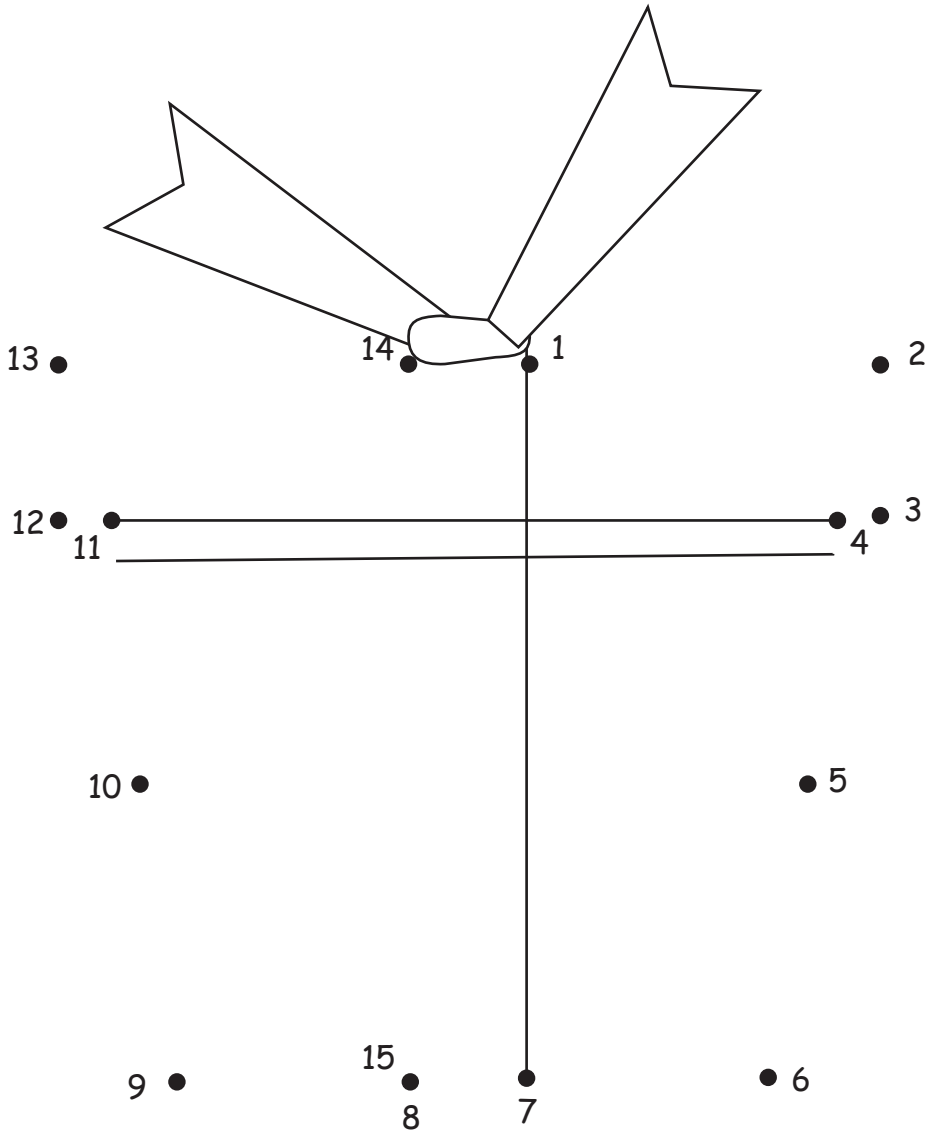

6



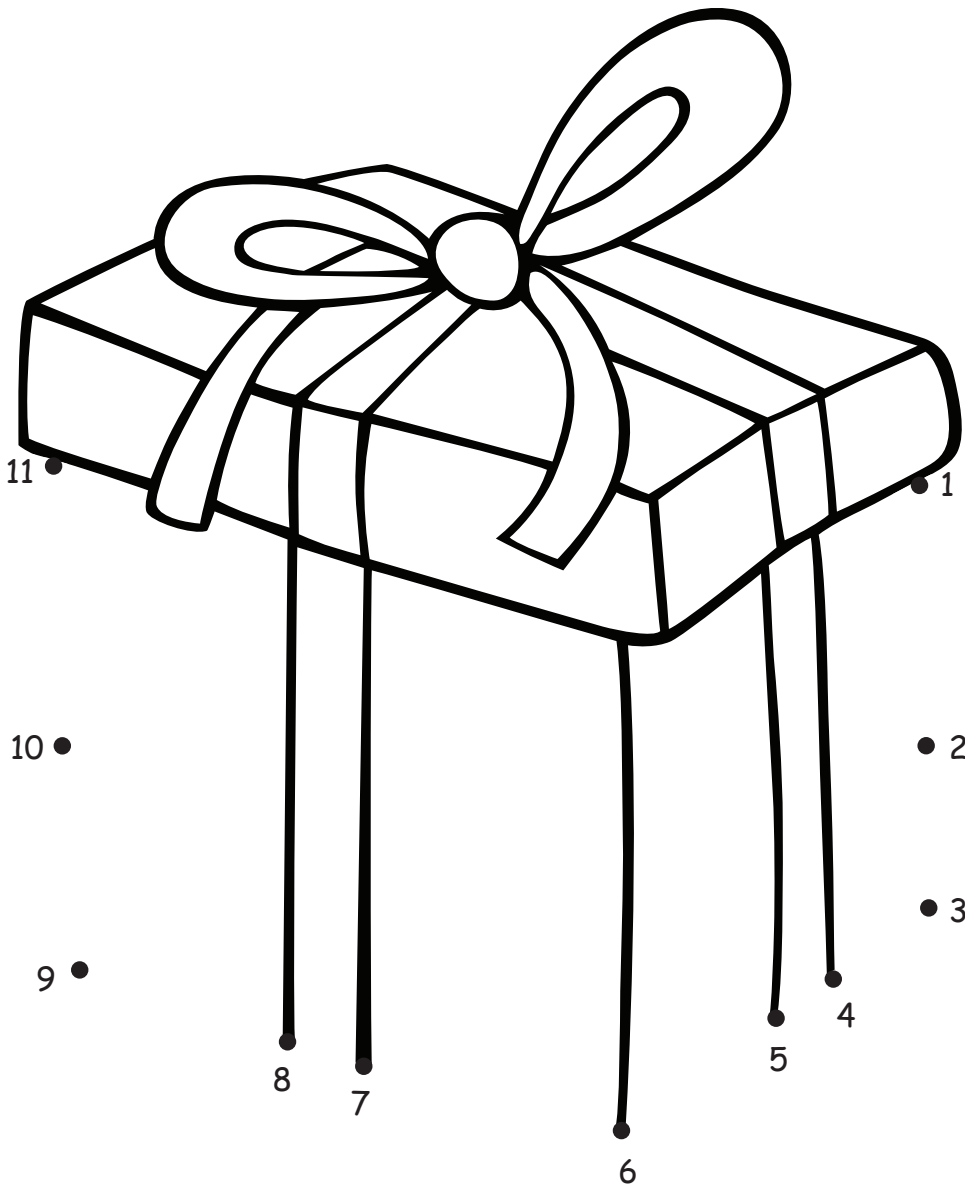

Name _____





Name _____



9



Name _____

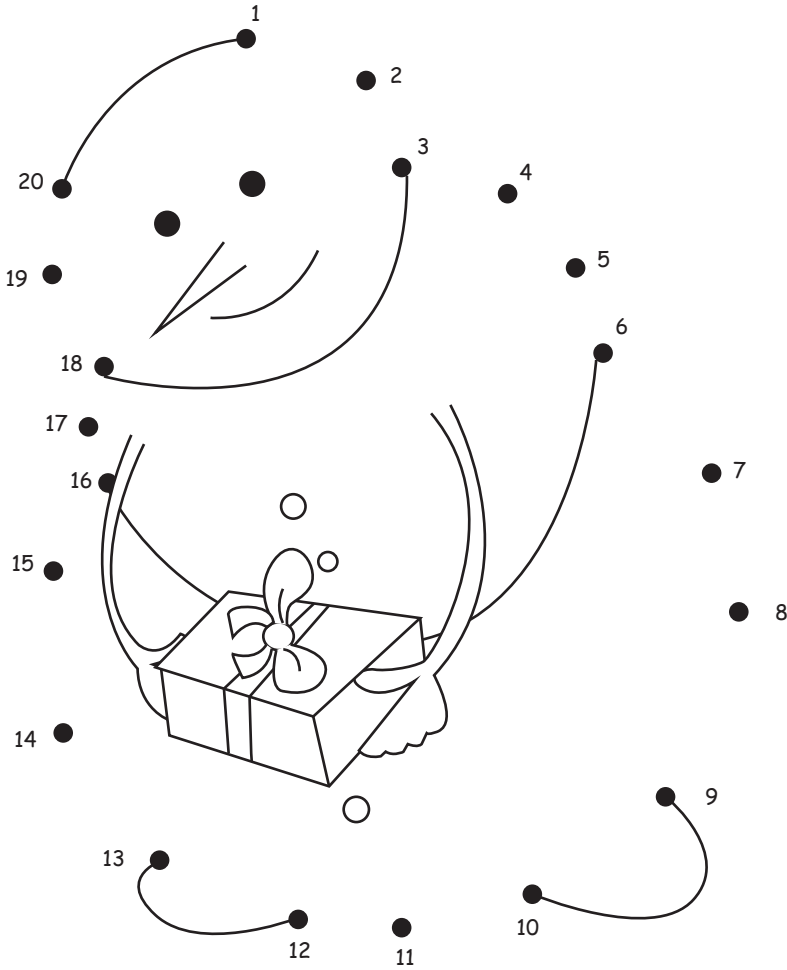

Name _____





11



Name _____

Cute[®]
Rascals



12



Name _____





10

CHRISTMAS MATH ACTIVITIES FOR KIDS



5

How many?



2



I have colored

christmas ornaments

count colors

10

I can see

Gingerbread man



HAPPY CHRISTMAS





This book belongs to



Name _____



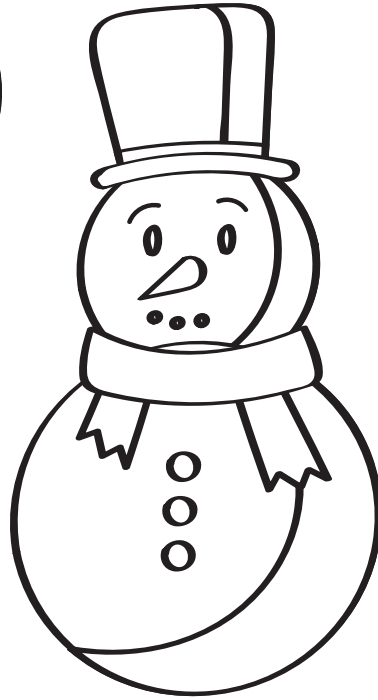
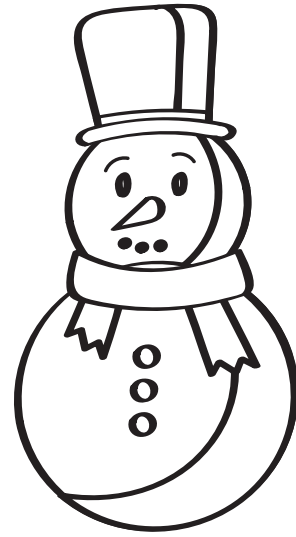
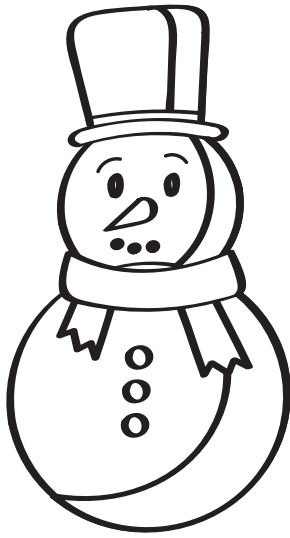

I can see



Snowmen

Name _____



1



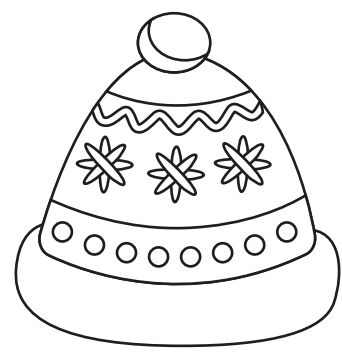
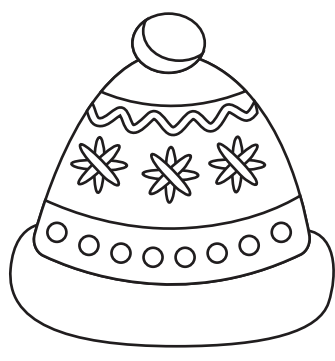
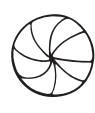

I can see

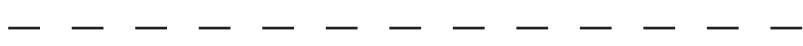

caps

Name _____





I can see

Snowflakes



Name _____



3



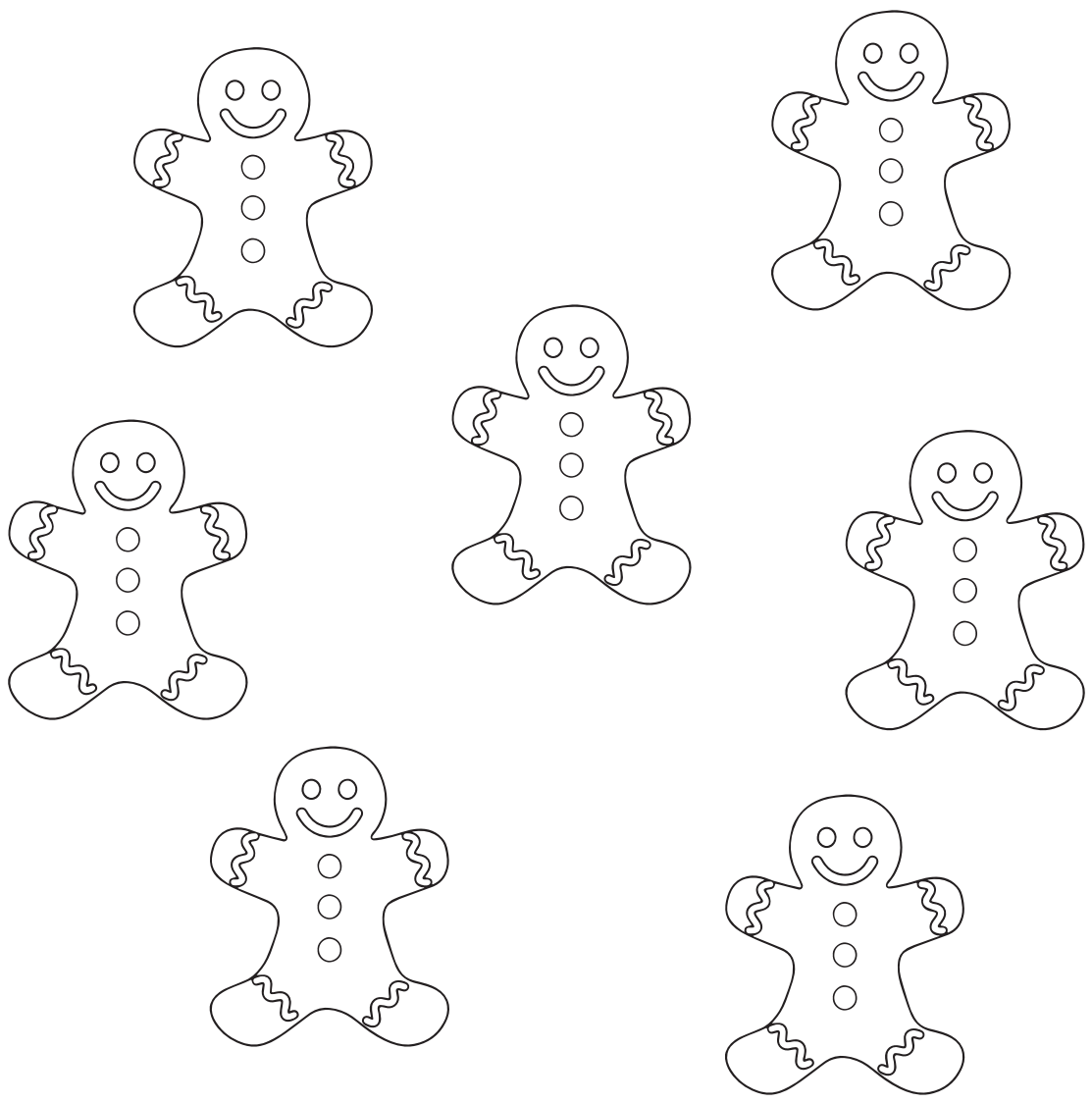

I can see

Gingerbread men



Name _____



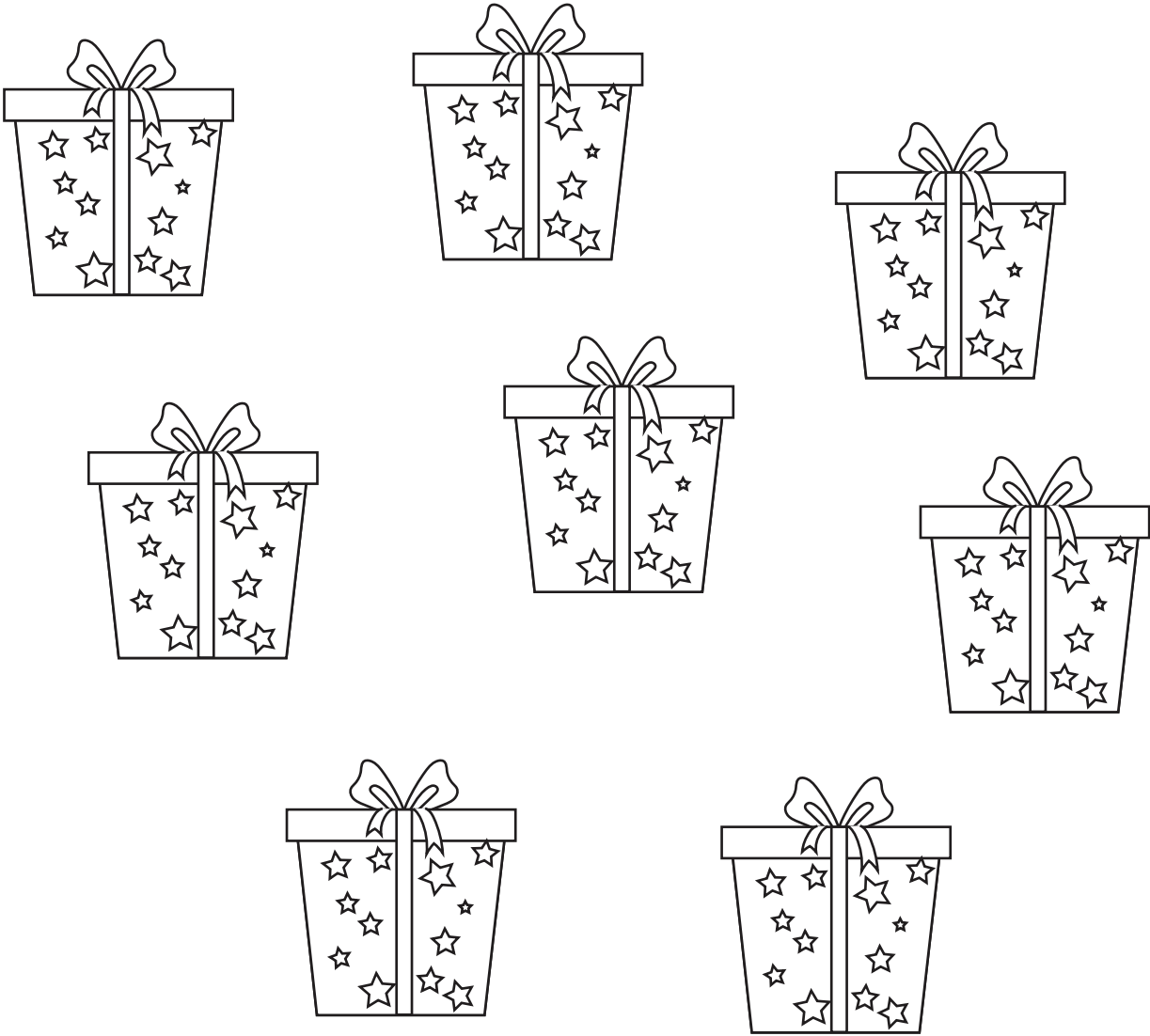

I can see

gift boxes

Name _____



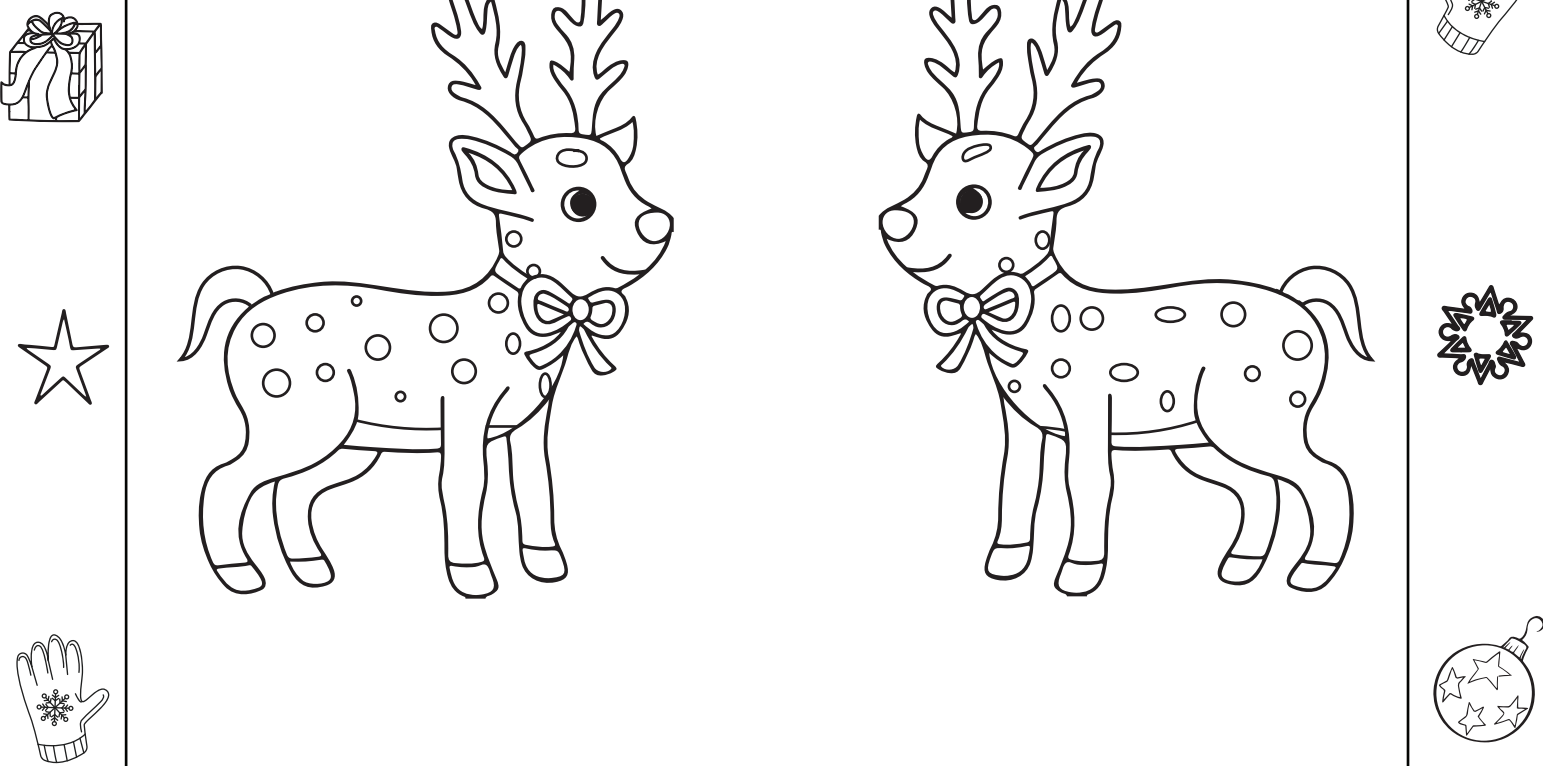
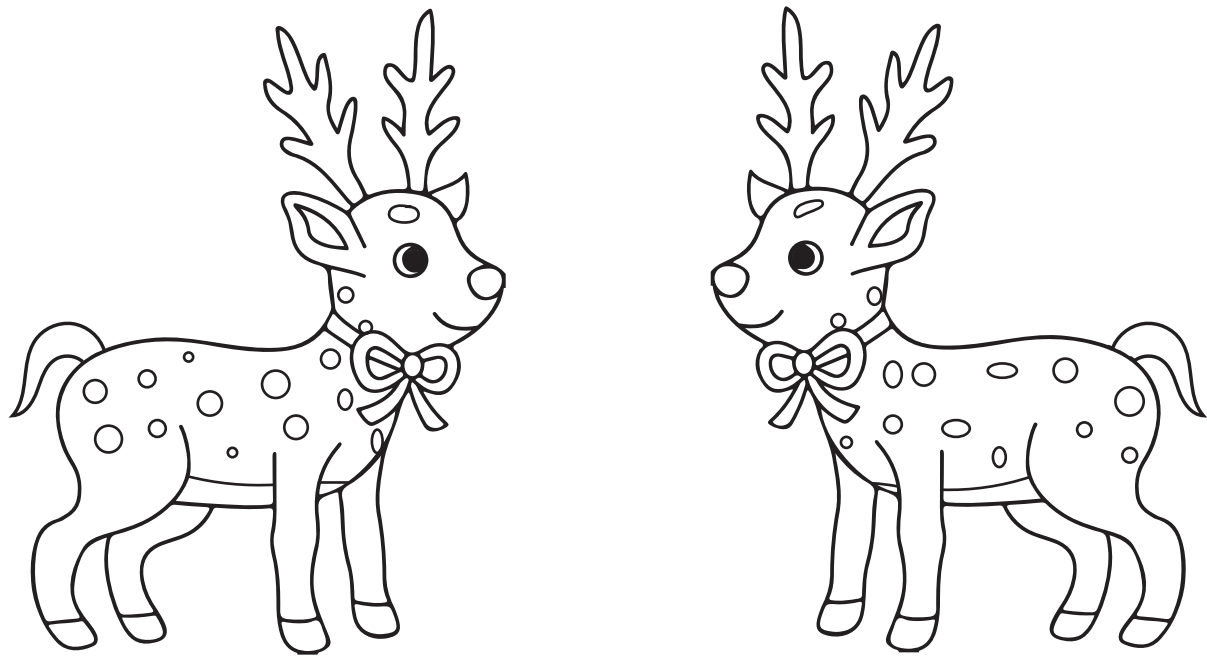

I have colored



reindeer

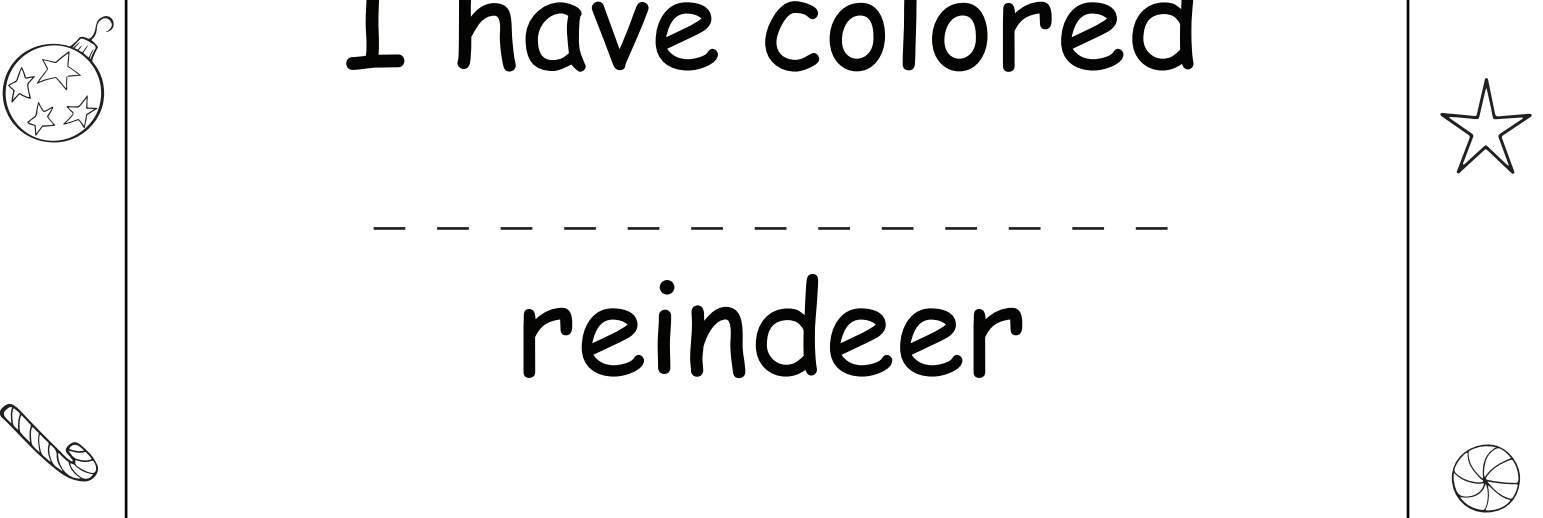

Name _____

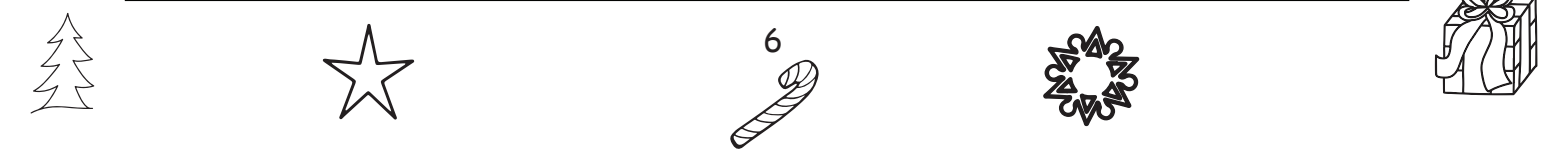

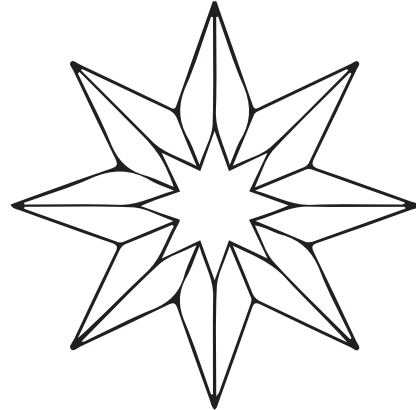
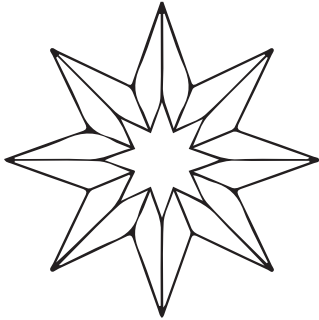
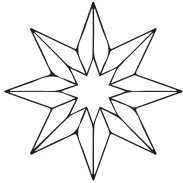
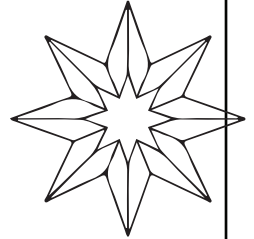
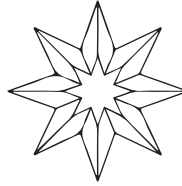
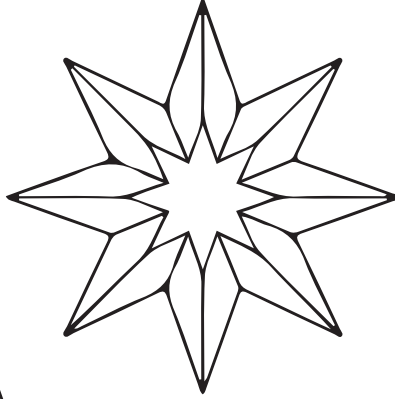
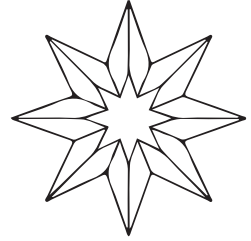
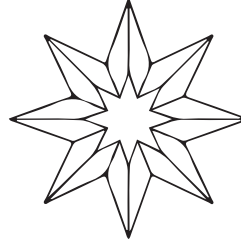
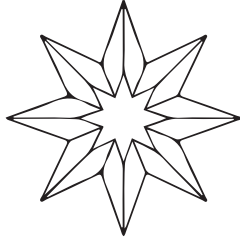
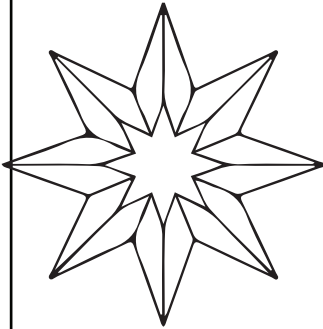

I can see



stars



Name _____



7



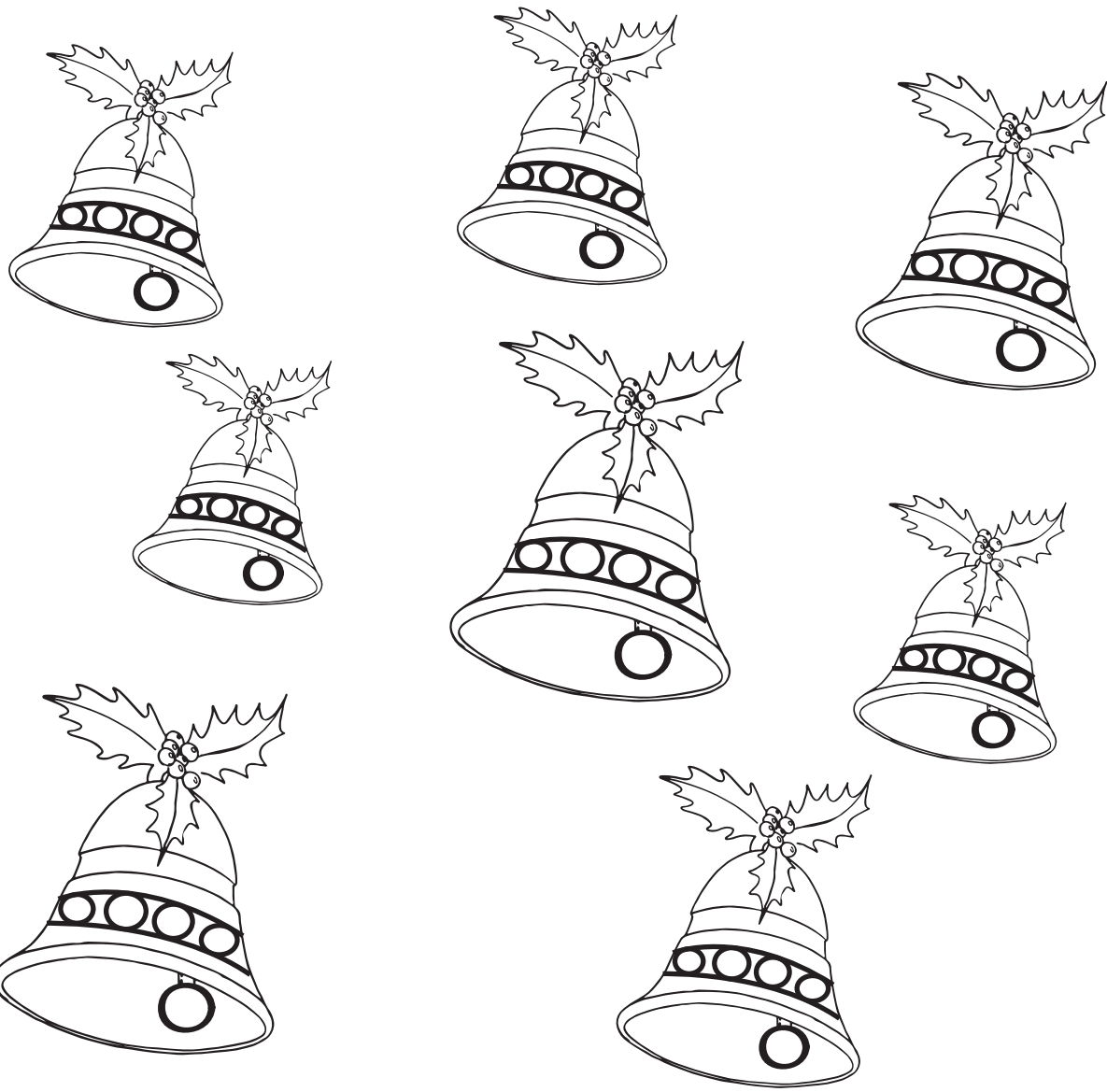

I can see

Christmas bells

Name _____





Name _____





I have colored

Christmas ornaments

Name _____





15

CHRISTMAS MAZE ACTIVITIES FOR KIDS



START

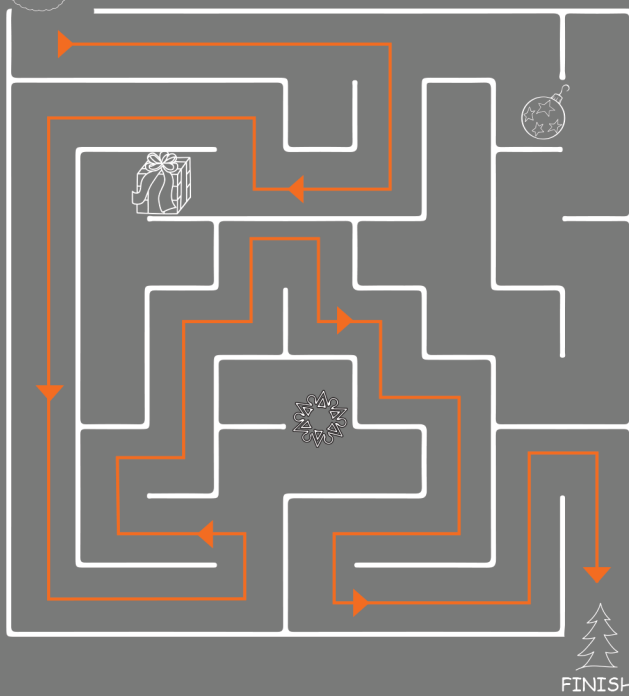

FINISH

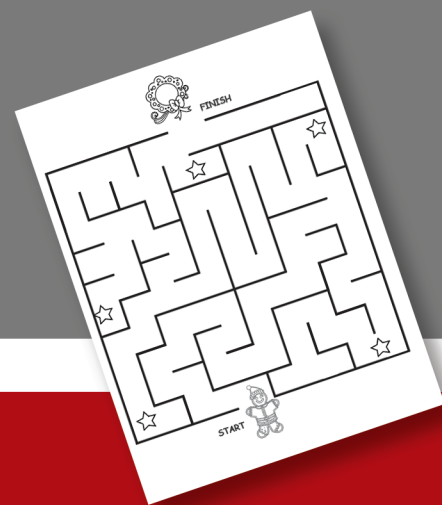
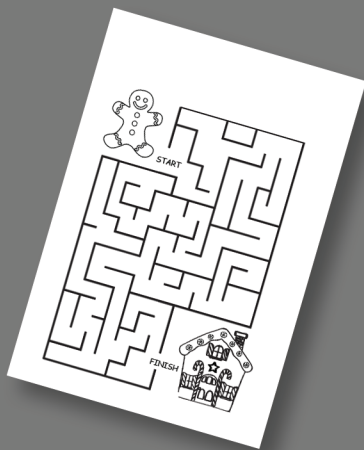

HAPPY CHRISTMAS





This book belongs to



Name _____



2





3

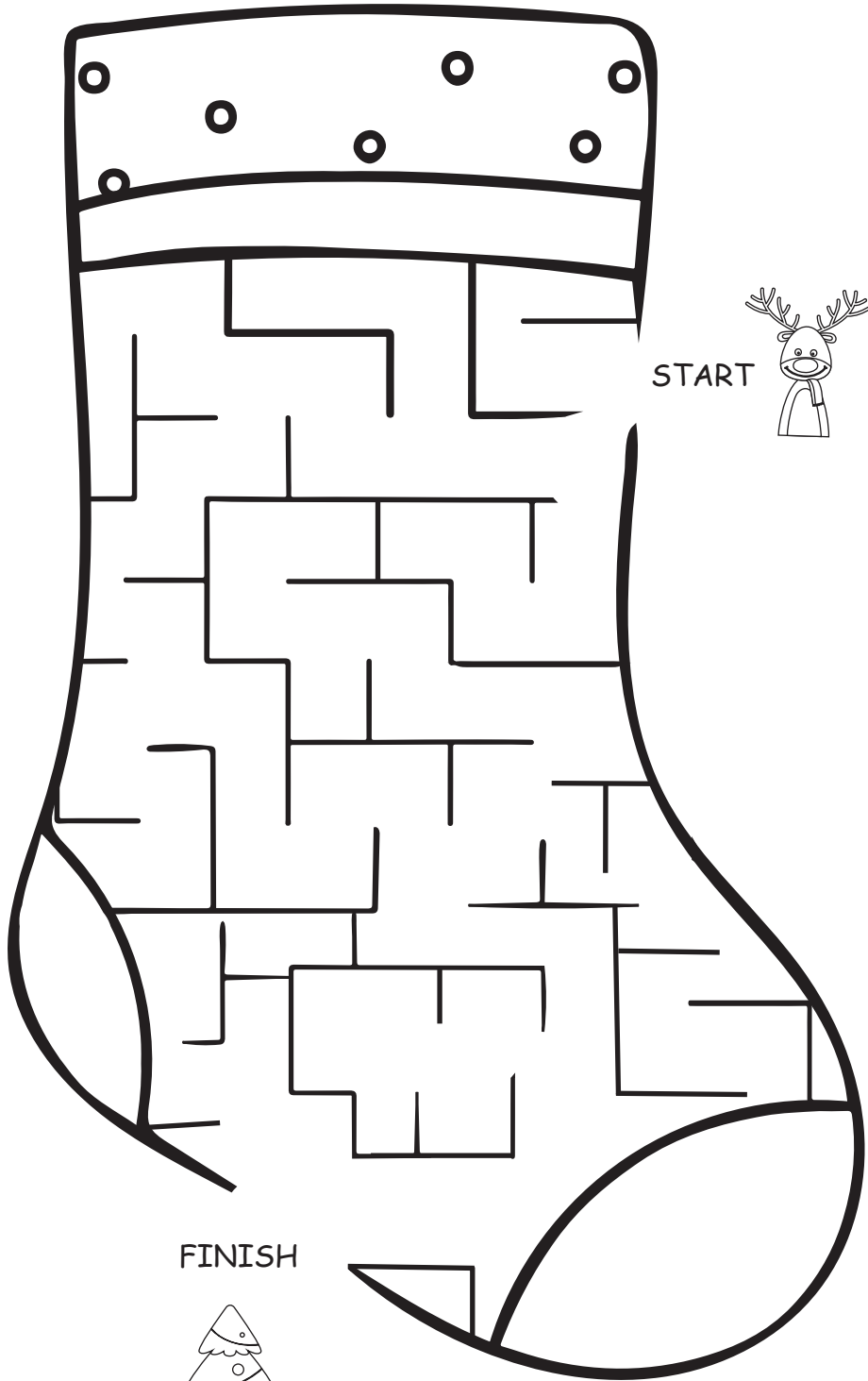

START

FINISH

Name _____



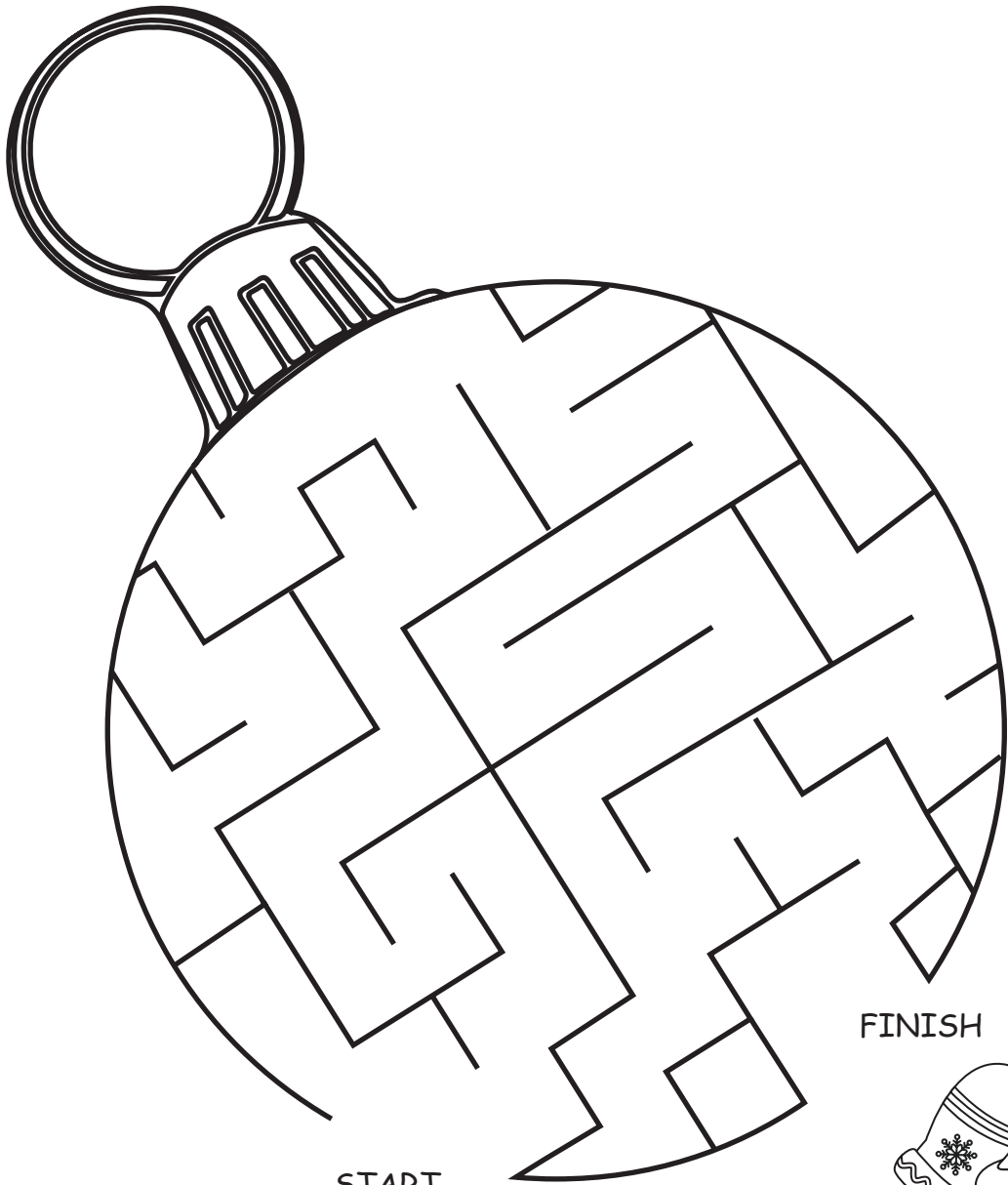

FINISH

START



Name _____



4





FINISH



START



Name _____



5





FINISH

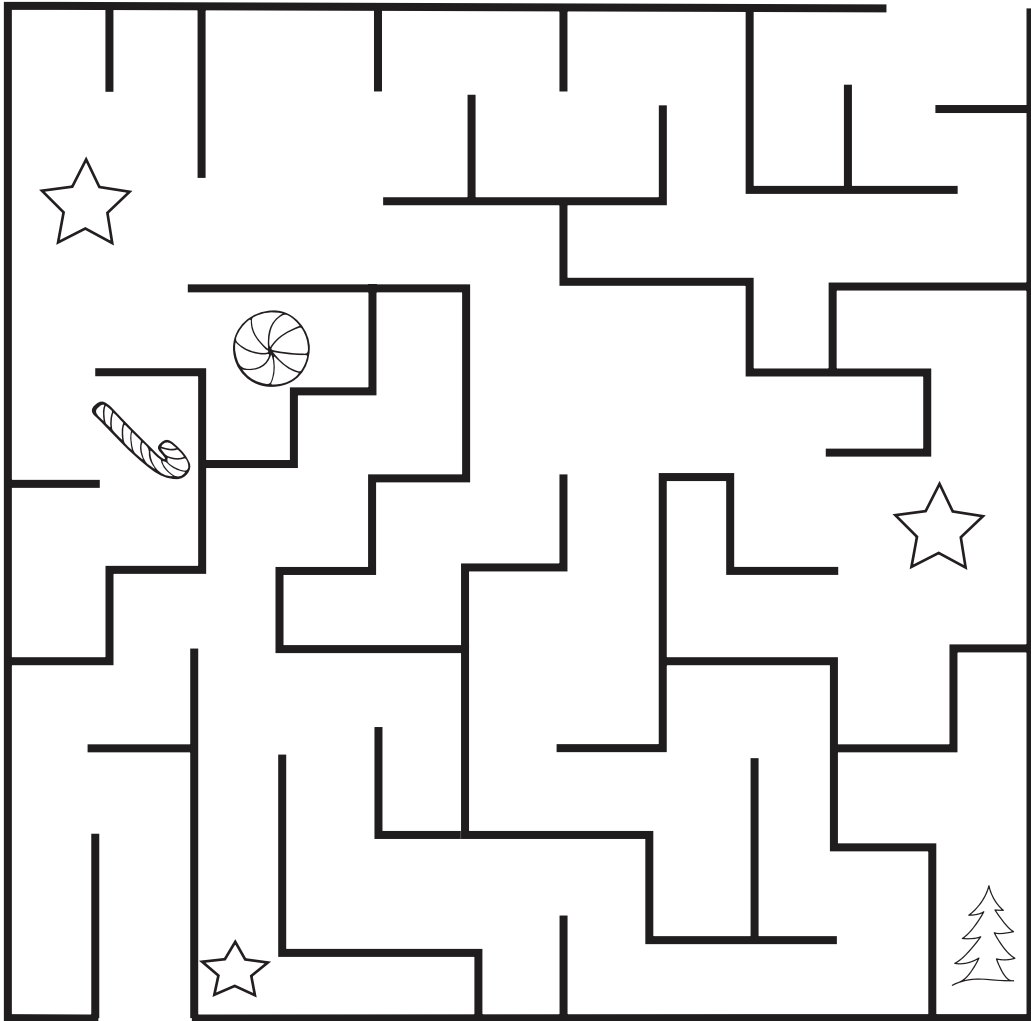

START



Name _____



6





7



FINISH

START

Name _____

Cute[®] Rascals



8



START 

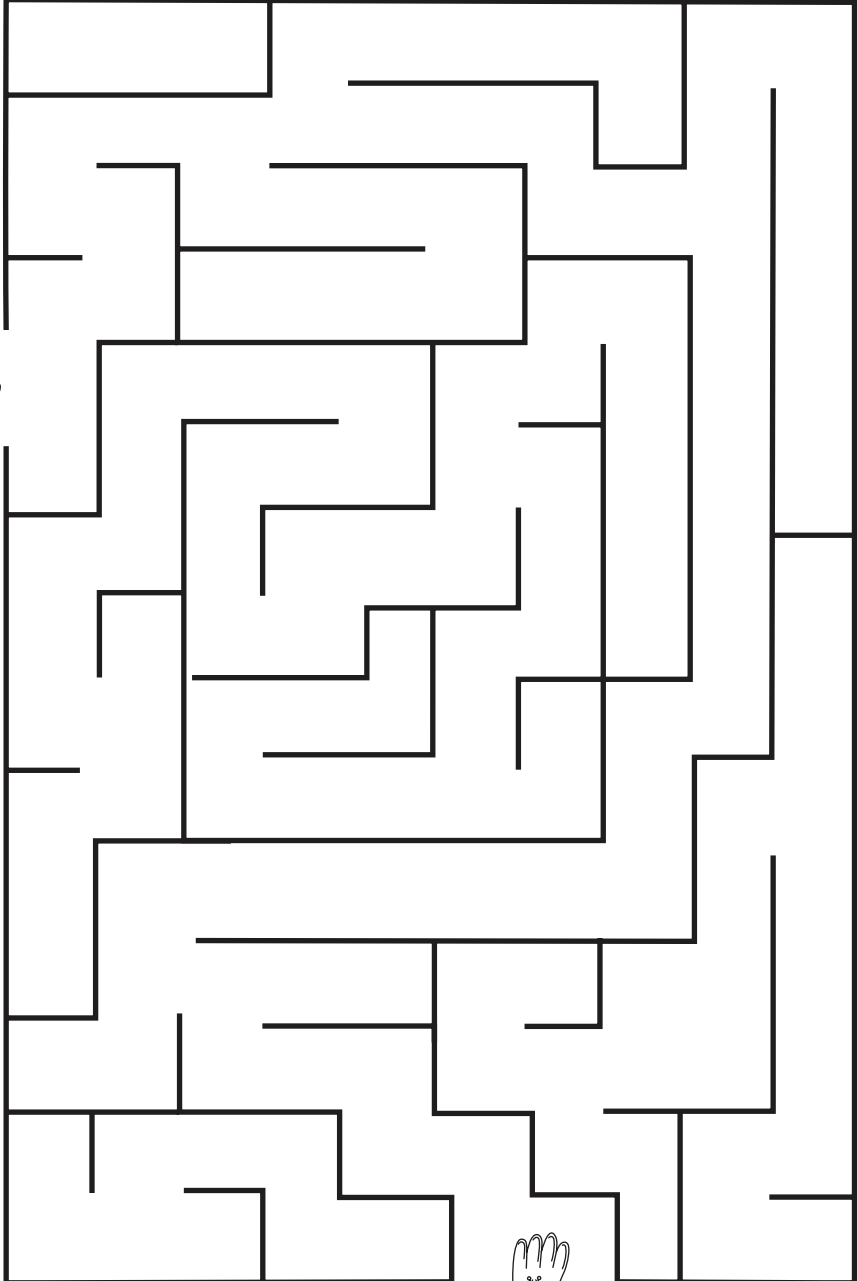

FINISH 

Name _____





START

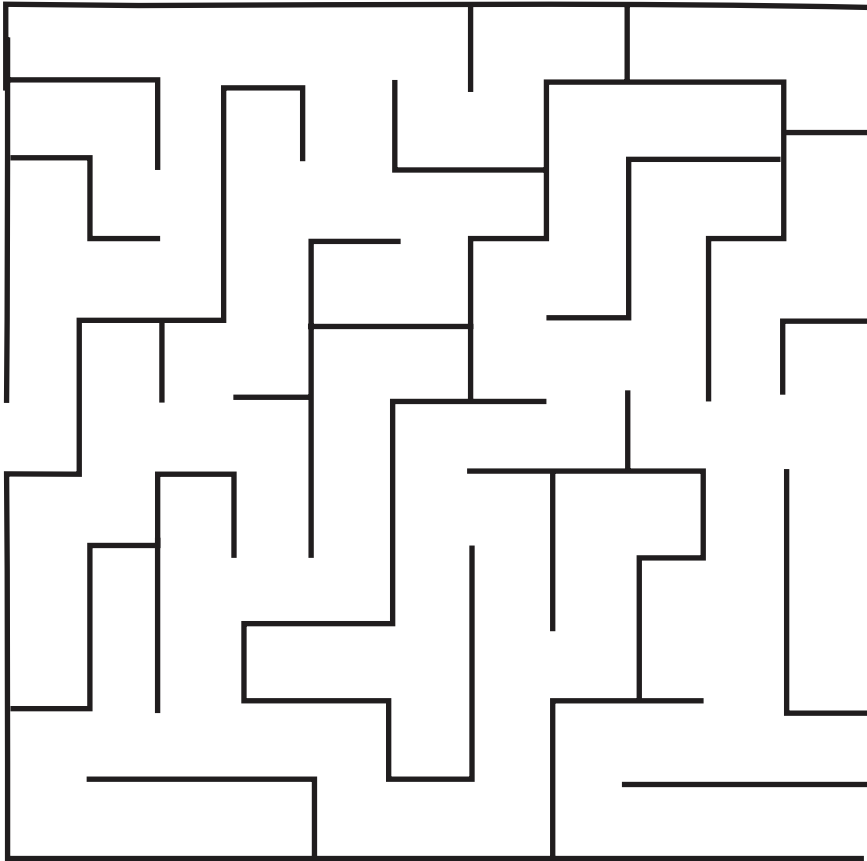

FINISH



Name _____



9





Name _____

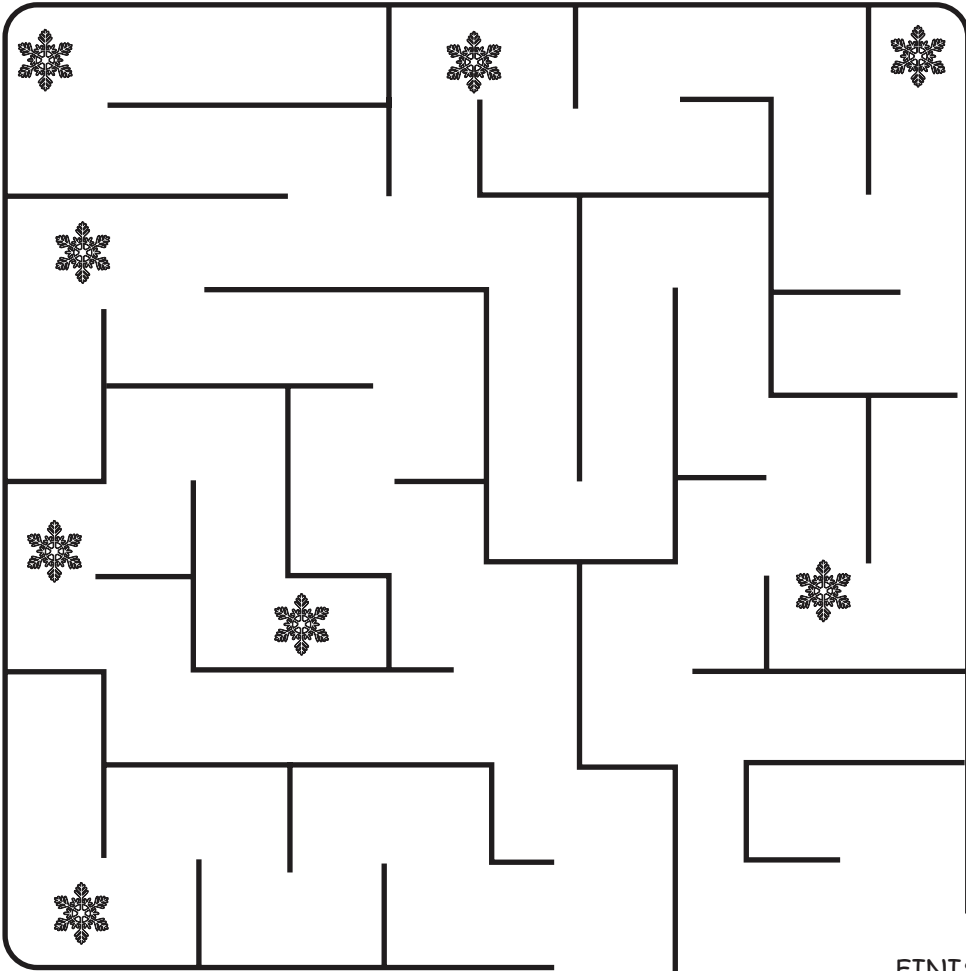

START

FINISH





START

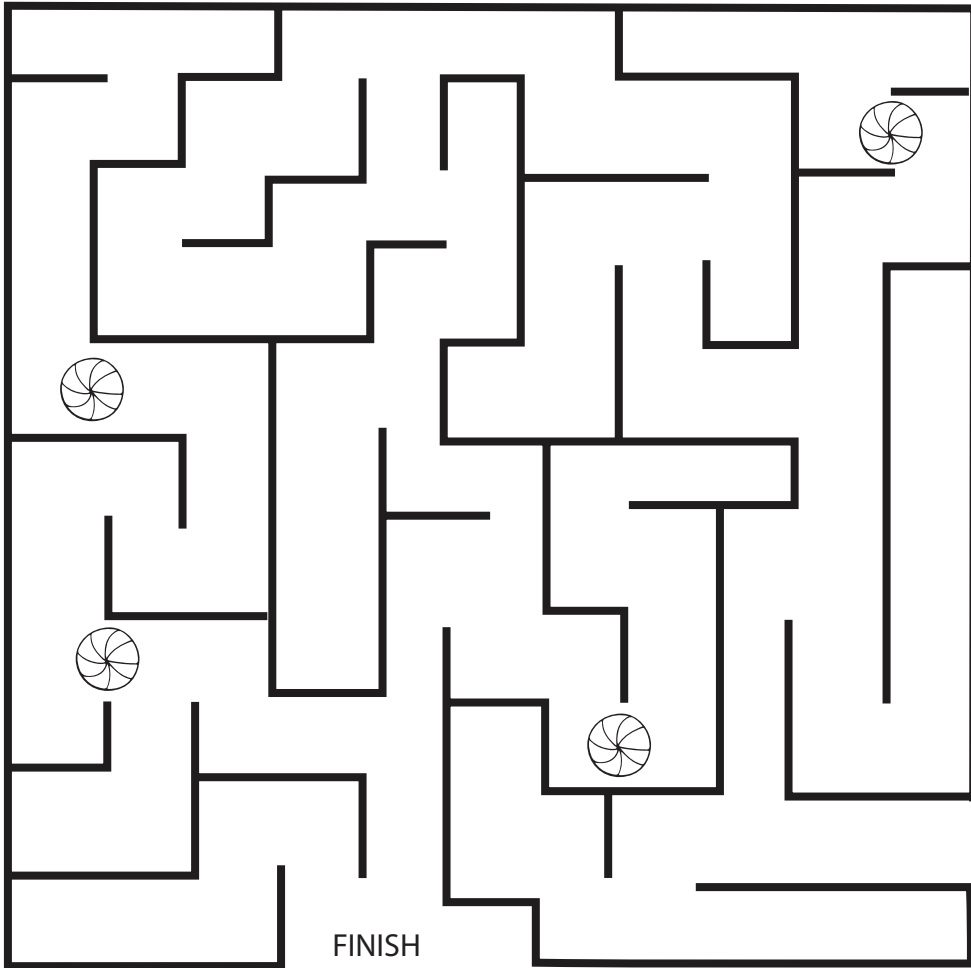

FINISH



Name _____



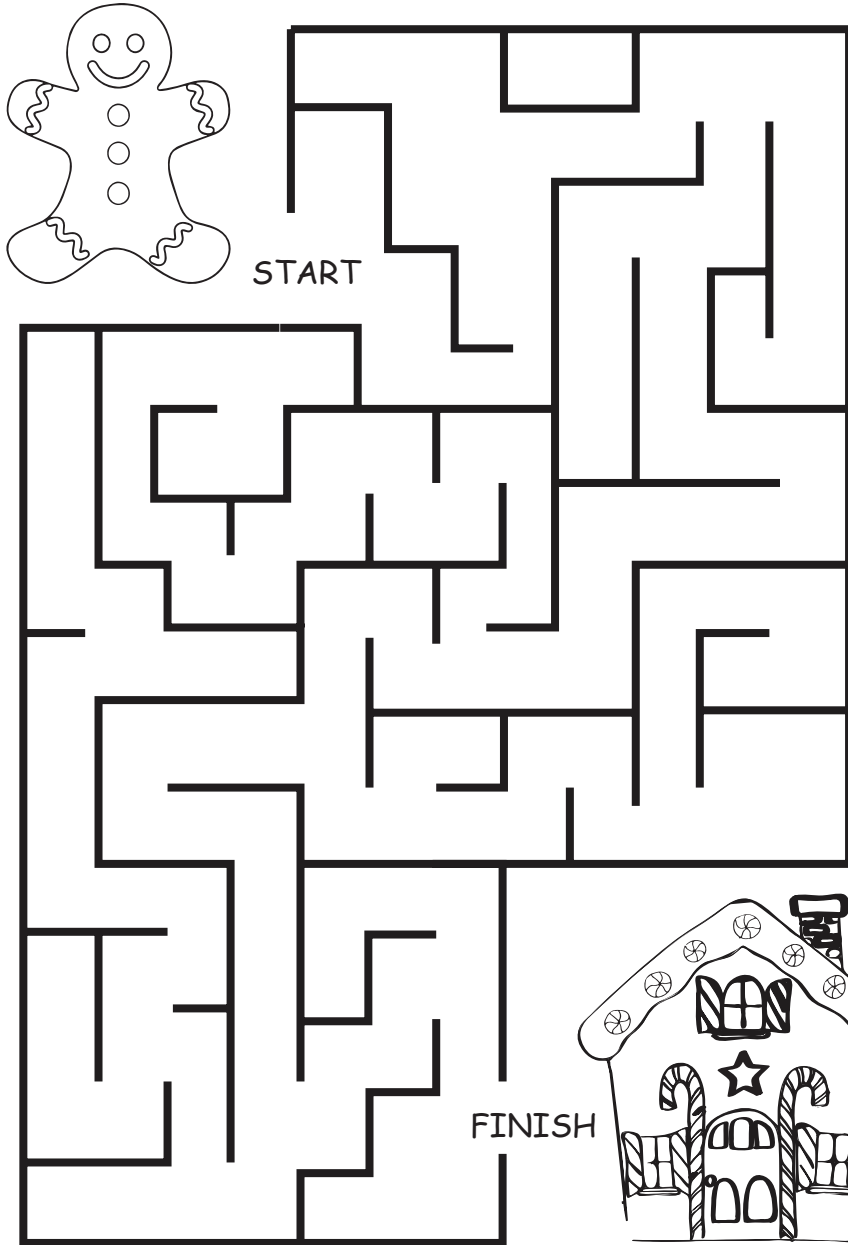

Name _____





FINISH

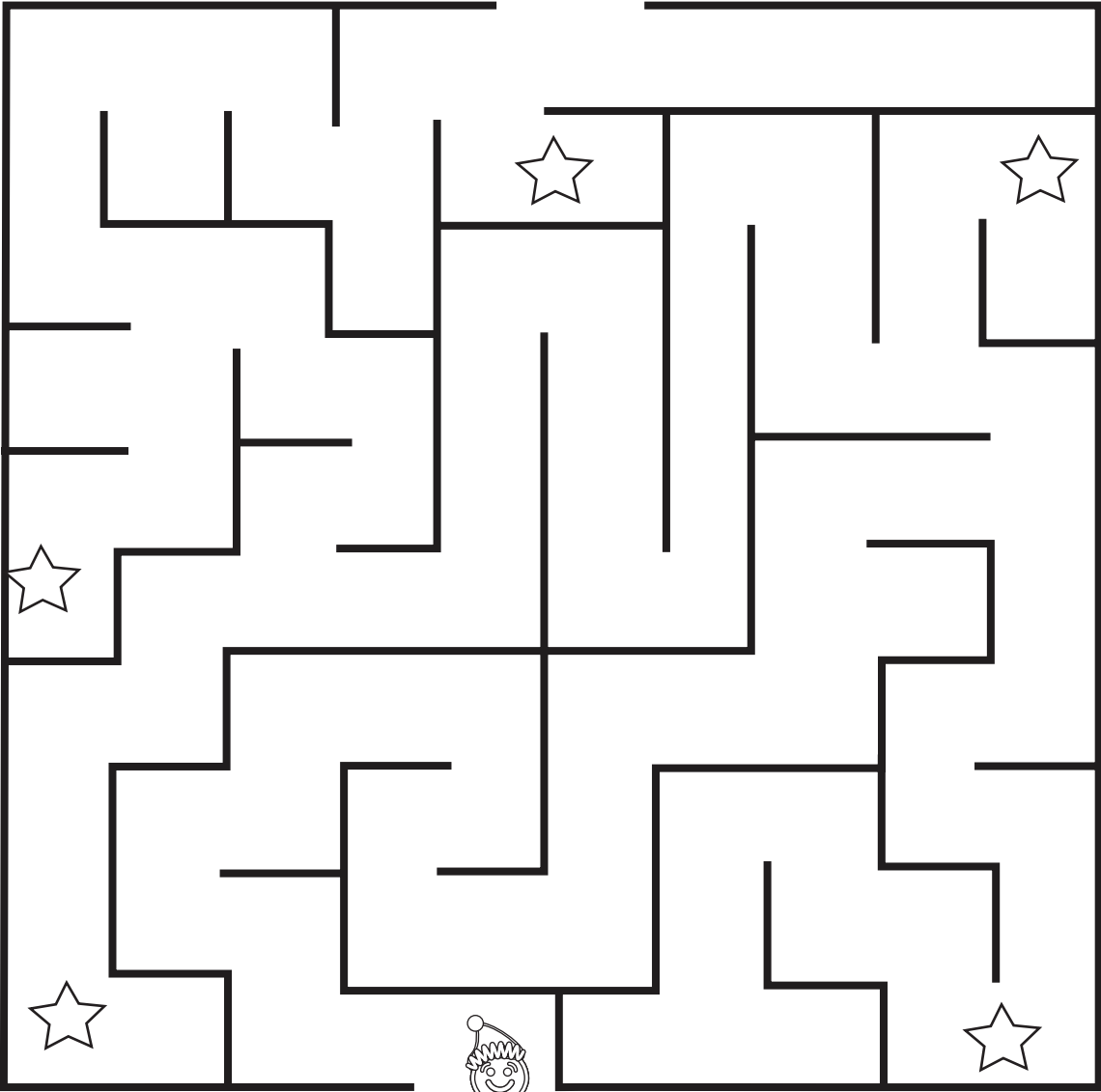

START



Name _____



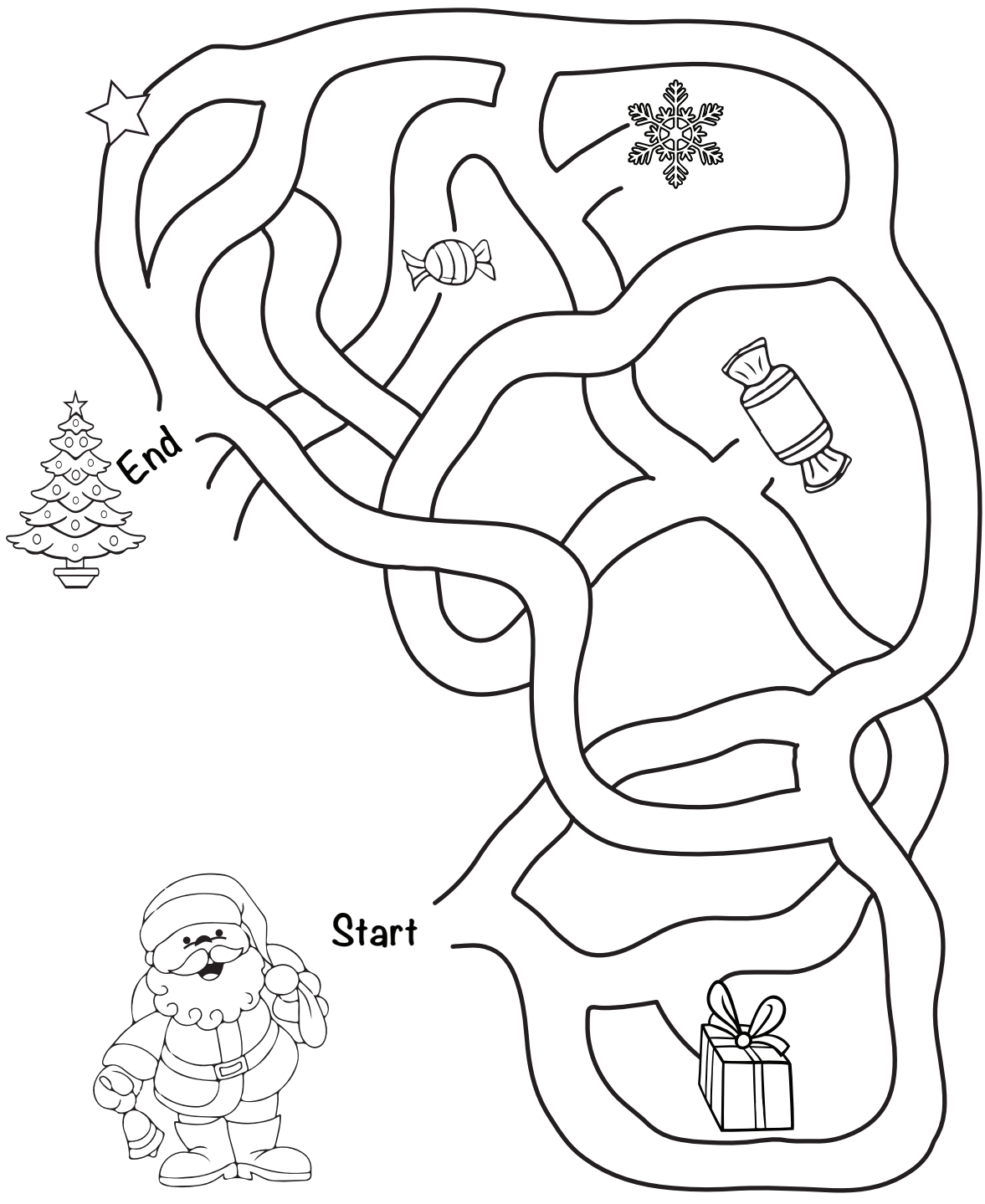

Start

End

Reach the christmas tree

Name _____





START

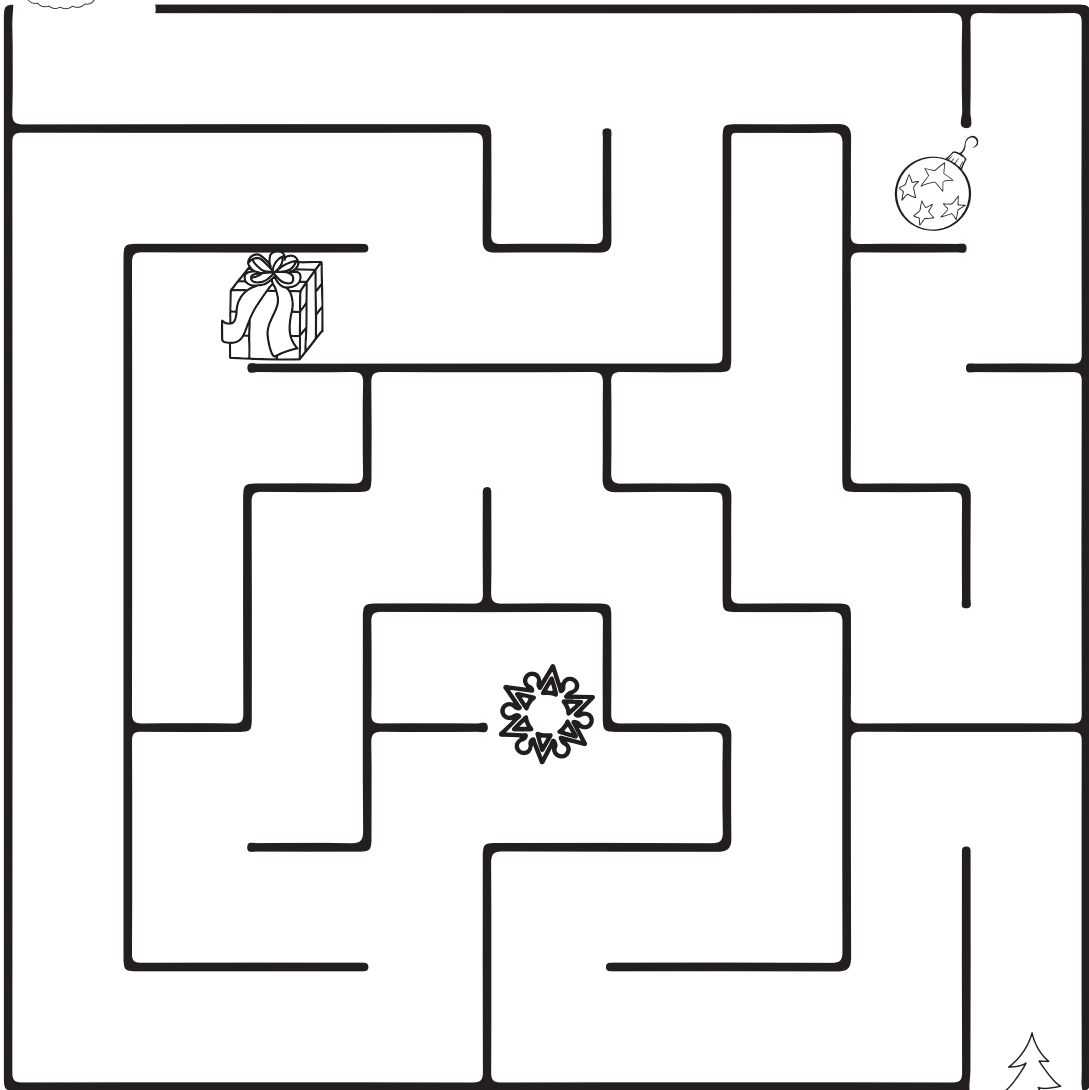

FINISH

Name _____





FINISH



START



Name _____





Name _____

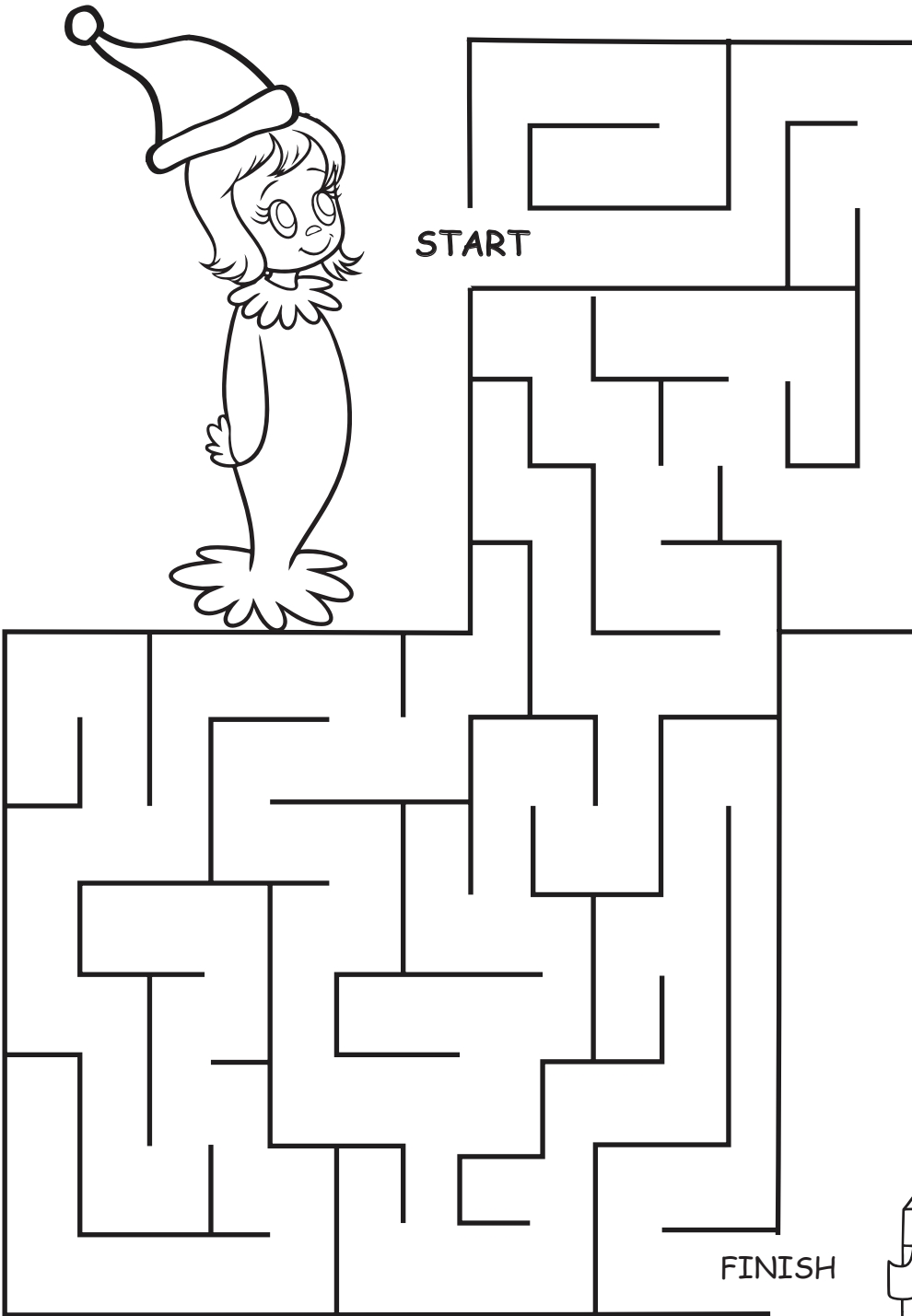



10

CHRISTMAS

HANDWRITING ACTIVITIES

FOR KIDS



Christmas HANDWRITING EXERCISE

cap

cap

cap

cap

snowman

snowman

snowman

Name _____

Cute Rascals

cap



jingle bells

snowman

Christmas HANDWRITING EXERCISE

santa claus

santa claus

santa claus

santa claus

jingle bells

jingle bells

jingle bells

jingle bells



HAPPY

CHRISTMAS





This book belongs to



Name _____



2





Christmas

HANDWRITING EXERCISE



santa claus



santa claus



santa claus



santa claus



jingle bells



jingle bells



jingle bells



jingle bells



Name _____



3





Christmas

HANDWRITING EXERCISE



tree



tree



tree



tree

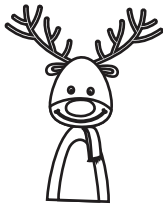

reindeer



reindeer



reindeer



reindeer



Name _____





Christmas

HANDWRITING EXERCISE

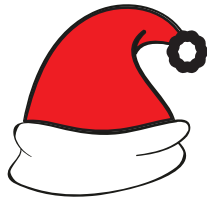

cap



cap



cap



cap



snowman



snowman



snowman



snowman



Name _____





Christmas

HANDWRITING EXERCISE

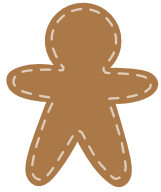

gingerbread



gingerbread



gingerbread



gingerbread



leaf



leaf



leaf



leaf



Name _____





Christmas

HANDWRITING EXERCISE



Grinch



Grinch



Grinch



Grinch



shoes



shoes



shoes



shoes



Name _____



7





Christmas

HANDWRITING EXERCISE



gift box



gift box



gift box



gift box



snowflakes



snowflakes



snowflakes



snowflakes



Name _____





Christmas

HANDWRITING EXERCISE



unwrap



unwrap



unwrap



unwrap



ornaments



ornaments



ornaments



ornaments



Name _____





Christmas

HANDWRITING EXERCISE



stocking



stocking



stocking



stocking



Christmas wreath



Christmas wreath



Christmas wreath



Christmas wreath



Name _____





Christmas

HANDWRITING EXERCISE



toys



toys



toys



toys



mitten



mitten



mitten



mitten



Name _____





Christmas

HANDWRITING EXERCISE



candle



candle



candle



candle



bulb



bulb



bulb



bulb



Name _____





26

CHRISTMAS LETTER TRACING ACTIVITIES FOR KIDS

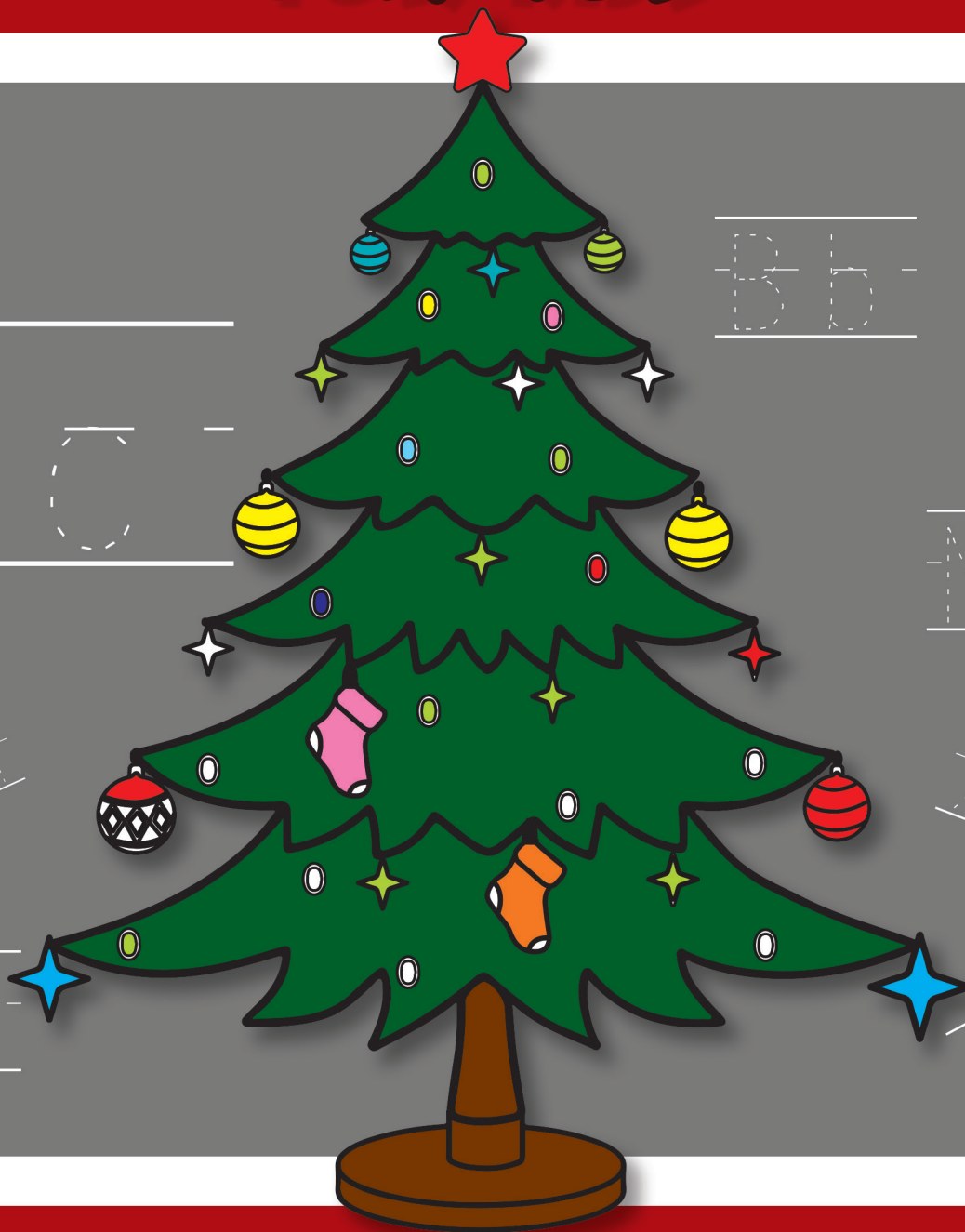
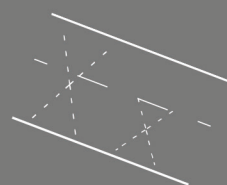
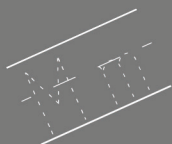
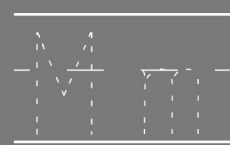
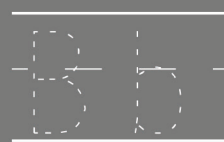
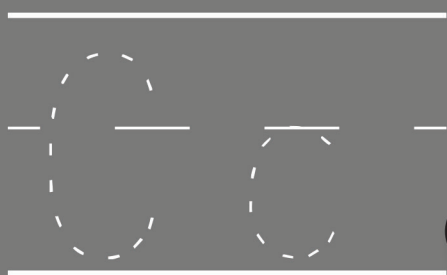

HAPPY CHRISTMAS





This book belongs to





Name _____



2





A

Christmas ALPHABET PRACTISE

a

A a

A a

A a

A a

A a

A a

A a

A a

A a

A a

A a

A a

A a

A a

A a

A a

A a

A a

A a

A a

A a

A a

A a

A a

A a

A a

A a

Name _____



3





B

Christmas ALPHABET PRACTISE

b

B b

B b

B b

B b

B b

B b

B b

B b

B b

B b

B b

B b

B b

B b

B b

B b

B b

B b

B b

B b

B b

B b

B b

B b

B b

B b

B b

Name _____





C

Christmas ALPHABET PRACTISE

C

C c

C c

C c

C c

C c

C c

C c

C c

C c

C c

C c

C c

C c

C c

C c

C c

C c

C c

C c

C c

C c

C c

C c

C c

C c

C c

C c



Name _____





D

Christmas ALPHABET PRACTISE

d

D d

D d

D d

D d

D d

D d

D d

D d

D d

D d

D d

D d

D d

D d

D d

D d

D d

D d

D d

D d

D d

D d

D d

D d

D d

D d

D d



Name _____





E

Christmas ALPHABET PRACTISE

e

E e

E e

E e

E e

E e

E e

E e

E e

E e

E e

E e

E e

E e

E e

E e

E e

E e

E e

E e

E e

E e

E e

E e

E e

E e

E e

E e

Name _____



7





F

Christmas ALPHABET PRACTISE

f

F f

F f

F f

F f

F f

F f

F f

F f

F f

F f

F f

F f

F f

F f

F f

F f

F f

F f

F f

F f

F f

F f

F f

F f

F f

F f

F f



Name _____





G

Christmas ALPHABET PRACTISE

g

G G

G G

G G

G G

G G

G G

G G

G G

G G

G G

G G

G G

G G

G G

G G

G G

G G

G G

G G

G G

G G

G G

G G

G G

G G

G G

G G



Name _____



9





H

Christmas ALPHABET PRACTISE

h

Hh

Hh

Hh

Hh

Hh

Hh

Hh

Hh

Hh

Hh

Hh

Hh

Hh

Hh

Hh

Hh

Hh

Hh

Hh

Hh

Hh

Hh

Hh

Hh

Hh

Hh

Hh



Name _____





I

Christmas ALPHABET PRACTISE

i



I

I

I

I

I

I



I

I

I



I

I

I



I

I

I

I

I

I

I

I

I

I

I

I

I

I

I



Name _____





J

Christmas ALPHABET PRACTISE

j

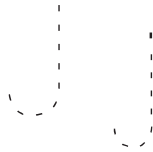
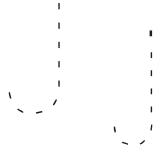
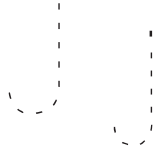
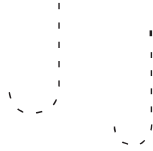
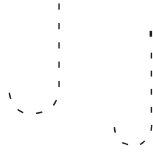
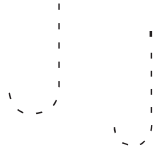
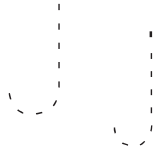
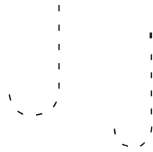
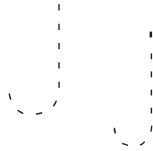

Name _____





K

Christmas ALPHABET PRACTISE

k

K K

K K

K K

K K

K K

K K

K K

K K

K K

K K

K K

K K

K K

K K

K K

K K

K K

K K

K K

K K

K K

K K

K K

K K

K K

K K

K K



Name _____





Christmas

ALPHABET PRACTISE



Name _____





M

Christmas ALPHABET PRACTISE

m

M m

M m

M m

M m

M m

M m

M m

M m

M m

M m

M m

M m

M m

M m

M m

M m

M m

M m

M m

M m

M m

M m

M m

M m

M m

M m

M m

Name _____





N

Christmas ALPHABET PRACTISE

n

N n

N n

N n

N n

N n

N n

N n

N n

N n

N n

N n

N n

N n

N n

N n

N n

N n

N n

N n

N n

N n

N n

N n

N n

N n

N n

N n

Name _____



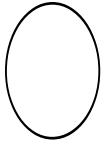

Christmas

ALPHABET PRACTISE

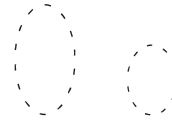

Name _____





P

Christmas ALPHABET PRACTISE

p

P p

P p

P p

P p

P p

P p

P p

P p

P p

P p

P p

P p

P p

P p

P p

P p

P p

P p

P p

P p

P p

P p

P p

P p

P p

P p

P p

Name _____





Q

Christmas

ALPHABET PRACTISE

q

Q q

Q q

Q q

Q q

Q q

Q q

Q q

Q q

Q q

Q q

Q q

Q q

Q q

Q q

Q q

Q q

Q q

Q q

Q q

Q q

Q q

Q q

Q q

Q q

Q q

Q q

Q q



Name _____





R

Christmas ALPHABET PRACTISE

r

Rr

Rr

Rr

Rr

Rr

Rr

Rr

Rr

Rr

Rr

Rr

Rr

Rr

Rr

Rr

Rr

Rr

Rr

Rr

Rr

Rr

Rr

Rr

Rr

Rr

Rr

Rr



Name _____





S

Christmas ALPHABET PRACTISE

S

S s

S s

S s

S s

S s

S s

S s

S s

S s

S s

S s

S s

S s

S s

S s

S s

S s

S s

S s

S s

S s

S s

S s

S s

S s

S s

S s



Name _____





T

Christmas ALPHABET PRACTISE

t



T t

T t

T t

T t

T t

T t



T t

T t

T t



T t

T t

T t



T t

T t

T t



T t

T t

T t



T t

T t

T t



T t

T t

T t

T t

T t

T t



Name _____





U

Christmas

ALPHABET PRACTISE

U

U U

U U

U U

U U

U U

U U

U U

U U

U U

U U

U U

U U

U U

U U

U U

U U

U U

U U

U U

U U

U U

U U

U U

U U

U U

U U

U U



Name _____



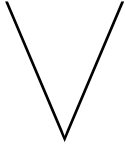

Christmas

ALPHABET PRACTISE

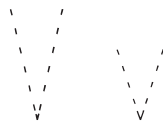
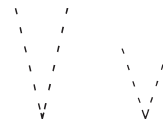
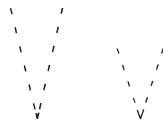
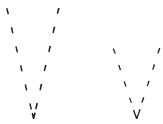
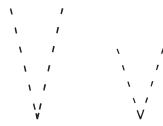
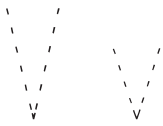
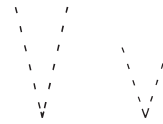
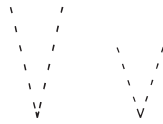
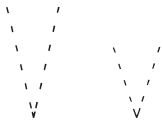
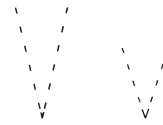
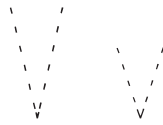
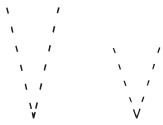
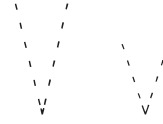
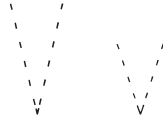
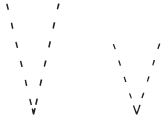
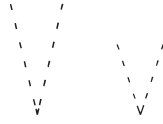
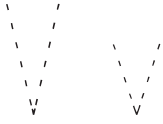
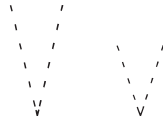
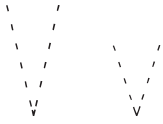
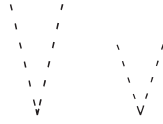
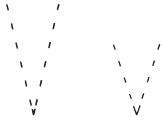

Name _____





W

Christmas ALPHABET PRACTISE

W

W W

W W

W W

W W

W W

W W

W W

W W

W W

W W

W W

W W

W W

W W

W W

W W

W W

W W

W W

W W

W W

W W

W W

W W

W W

W W

W W



Name _____



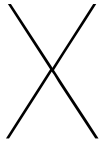

Christmas

ALPHABET PRACTISE

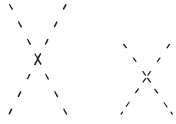

Name _____





Y

Christmas ALPHABET PRACTISE

Y

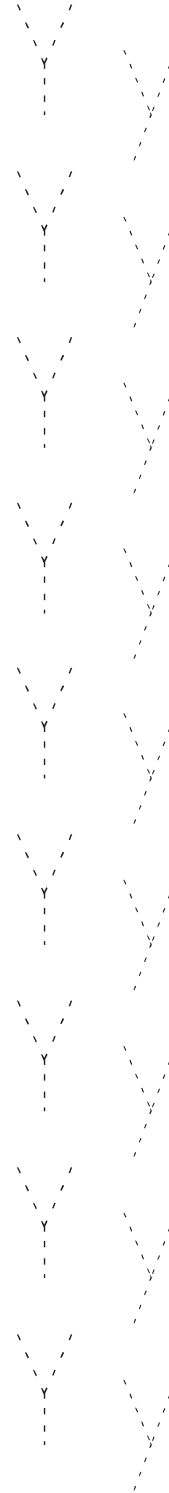
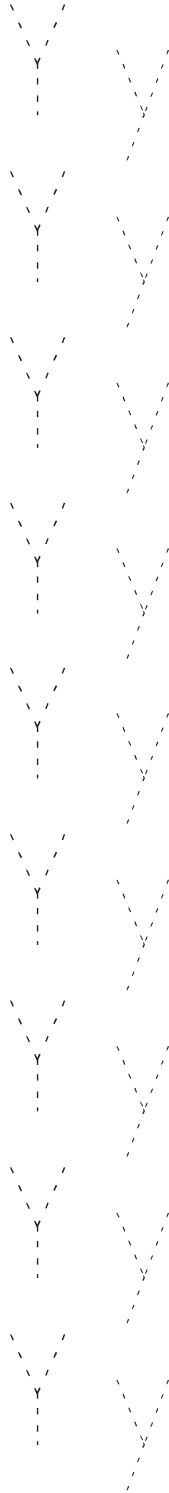
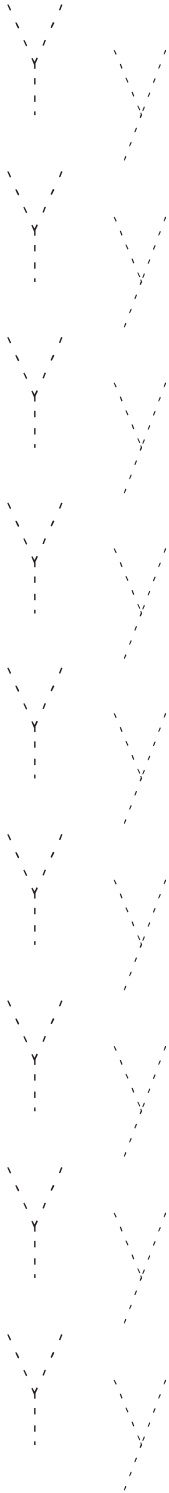

Name _____





Z

Christmas ALPHABET PRACTISE

Z

Z Z

Z Z

Z Z

Z Z

Z Z

Z Z

Z Z

Z Z

Z Z

Z Z

Z Z

Z Z

Z Z

Z Z

Z Z

Z Z

Z Z

Z Z

Z Z

Z Z

Z Z

Z Z

Z Z

Z Z

Z Z

Z Z

Z Z



Name _____



101 PAGES TO COLOR

HOURS OF FUN



Merry
Christmas

The ultimate Christmas
Coloring Activity for Kids